

SIEMENS

MICROMASTER 410

Operating Instructions

Issue 07/05



MICROMASTER 410 Documentation

Getting Started Guide

Is for quick commissioning.



Operating Instructions

Gives information about features of the MM410, Installation, Commissioning, Control modes, System Parameter structure, Troubleshooting, Specifications and available options of the MM410.



Parameter List

The Parameter List contains the description of all Parameters structured in functional order and a detailed description.



Catalogues

In the catalogue you will find all the necessary information to select an appropriate inverter, as well as filters, chokes, operator panels and communication options.



SIEMENS

MICROMASTER 410

Operating Instructions User Documentation

Valid for

Converter Type
MICROMASTER 410

Issue 07/05

Software version
V1.6

Overview	1
Installation	2
Commissioning	3
Using the MICROMASTER 410	4
System Parameters	5
Troubleshooting	6
MICROMASTER 410 Specifications	7
Available options	8
Electro-Magnetic Compatibility	9
Appendices	A B C
Index	

IMPORTANT NOTICE

UL listing can be determined by examining the inverter's Rating Label.

For UL listed products the following UL mark is used:



Further information can be obtained from Internet website:

<http://www.siemens.de/micromaster>

Approved Siemens Quality for Software and Training is to DIN ISO 9001, Reg. No. 2160-01

The reproduction, transmission or use of this document, or its contents is not permitted unless authorized in writing. Offenders will be liable for damages. All rights including rights created by patent grant or registration of a utility model or design are reserved.

© Siemens AG 2001, 2005. All Rights Reserved.

MICROMASTER® is a registered trademark of Siemens

Other functions not described in this document may be available. However, this fact shall not constitute an obligation to supply such functions with a new control, or when servicing.

We have checked that the contents of this document correspond to the hardware and software described. There may be discrepancies nevertheless, and no guarantee can be given that they are completely identical. The information contained in this document is reviewed regularly and any necessary changes will be included in the next edition. We welcome suggestions for improvement.

Siemens handbooks are printed on chlorine-free paper that has been produced from managed sustainable forests. No solvents have been used in the printing or binding process.

Document subject to change without prior notice.

Order number: 6SE6400-5EA00-0BP0

Siemens-Aktiengesellschaft

Foreword

User Documentation



WARNING

Before installing and commissioning the inverter, you must read all safety instructions and warnings carefully including all the warning labels attached to the equipment. Make sure that the warning labels are kept in a legible condition and replace missing or damaged labels.

Information is also available from:

Technical Support Nuremberg

Tel: +49 (0) 180 5050 222

Fax: +49 (0) 180 5050 223

Email: techsupport@ad.siemens.de

Monday to Friday: 7:00 am to 5:00 pm (Central European Time)

Internet Home Address

Customers can access technical and general information at:

<http://www.siemens.de/micromaster>

Contact address

Should any questions or problems arise while reading this manual, please contact the Siemens office concerned using the form provided at the back of this manual.

Definitions and Warnings



DANGER

indicates an imminently hazardous situation which, if not avoided, will result in death or serious injury.



WARNING

indicates a potentially hazardous situation which, if not avoided, could result in death or serious injury.



CAUTION

used with the safety alert symbol indicates a potentially hazardous situation which, if not avoided, may result in minor or moderate injury.

CAUTION

used without safety alert symbol indicates a potentially hazardous situation which, if not avoided, may result in a property damage.

NOTICE

indicates a potential situation which, if not avoided, may result in an undesirable result or state.

NOTES

For the purpose of this documentation, "Note" indicates important information relating to the product or highlights part of the documentation for special attention.

Qualified personnel

For the purpose of this Instruction Manual and product labels, a "Qualified person" is someone who is familiar with the installation, mounting, start-up and operation of the equipment and the hazards involved.

He or she must have the following qualifications:

1. Trained and authorized to energize, de-energize, clear, ground and tag circuits and equipment in accordance with established safety procedures.
2. Trained in the proper care and use of protective equipment in accordance with established safety procedures.
3. Trained in rendering first aid.



- ◆ PE – Protective Earth uses circuit protective conductors sized for short circuits where the voltage will not rise in excess of 50 Volts. This connection is normally used to ground the inverter.

- ◆ - Is the ground connection where the reference voltage can be the same as the Earth voltage. This connection is normally used to ground the motor.

Use for intended purpose only

The equipment may be used only for the application stated in the manual and only in conjunction with devices and components recommended and authorized by Siemens.

Safety Instructions

The following Warnings, Cautions and Notes are provided for your safety and as a means of preventing damage to the product or components in the machines connected. This section lists Warnings, Cautions and Notes, which apply generally when handling MICROMASTER 410 Inverters, classified as **General, Transport & Storage, Commissioning, Operation, Repair and Dismantling & Disposal**.

Specific Warnings, Cautions and Notes that apply to particular activities are listed at the beginning of the relevant chapters and are repeated or supplemented at critical points throughout these sections.

Please read the information carefully, since it is provided for your personal safety and will also help prolong the service life of your MICROMASTER 410 Inverter and the equipment you connect to it.

General



WARNING

- ◆ This equipment contains dangerous voltages and controls potentially dangerous rotating mechanical parts. Non-compliance with **Warnings** or failure to follow the instructions contained in this manual can result in loss of life, severe personal injury or serious damage to property.
- ◆ Only suitable qualified personnel should work on this equipment, and only after becoming familiar with all safety notices, installation, operation and maintenance procedures contained in this manual. The successful and safe operation of this equipment is dependent upon its proper handling, installation, operation and maintenance.
- ◆ Risk of electric shock. The DC link capacitors remain charged for five minutes after power has been removed. **It is not permissible to open the equipment until 5 minutes after the power has been removed.**



CAUTION

- ◆ Children and the general public must be prevented from accessing or approaching the equipment!
- ◆ This equipment may only be used for the purpose specified by the manufacturer. Unauthorized modifications and the use of spare parts and accessories that are not sold or recommended by the manufacturer of the equipment can cause fires, electric shocks and injuries.

NOTES

- ◆ Keep these operating instructions within easy reach of the equipment and make them available to all users
 - ◆ Whenever measuring or testing has to be performed on live equipment, the regulations of Safety Code VBG 4.0 must be observed, in particular §8 "Permissible Deviations when Working on Live Parts". Suitable electronic tools should be used.
 - ◆ Before installing and commissioning, please read these safety instructions and warnings carefully and all the warning labels attached to the equipment. Make sure that the warning labels are kept in a legible condition and replace missing or damaged labels
-

Transport & Storage



WARNING

- ◆ Correct transport, storage, erection and mounting, as well as careful operation and maintenance are essential for proper and safe operation of the equipment.
-



CAUTION

- ◆ Protect the inverter against physical shocks and vibration during transport and storage. Also be sure to protect it against water (rainfall) and excessive temperatures (see table on page 19).
-

Commissioning



WARNINGS

- ◆ Work on the device/system by **unqualified** personnel or failure to comply with warnings can result in severe personal injury or serious damage to material. Only suitably qualified personnel trained in the setup, installation, commissioning and operation of the product should carry out work on the device/system.
 - ◆ Only permanently-wired input power connections are allowed. This equipment must be grounded (IEC 536 Class 1, NEC and other applicable standards).
 - ◆ If a Residual Current-operated protective Device (RCD) is to be used, it must be an RCD type B.
 - ◆ The following terminals can carry dangerous voltages even if the inverter is inoperative:
 - the power supply terminals L and N.
 - the motor terminals U, V, W and the terminals DC+ and DC-.
 - ◆ This equipment must not be used as an 'emergency stop mechanism' (see EN 60204, 9.2.5.4)
-



CAUTION

The connection of power, motor and control cables to the inverter must be carried out as shown in Figure 2-10 on page 30, to prevent inductive and capacitive interference from affecting the correct functioning of the inverter.

Operation



WARNING

- ◆ MICROMASTERS operate at high voltages.
 - ◆ When operating electrical devices, it is impossible to avoid applying hazardous voltages to certain parts of the equipment.
 - ◆ Emergency Stop facilities according to EN 60204 IEC 204 (VDE 0113) must remain operative in all operating modes of the control equipment. Any disengagement of the Emergency Stop facility must not lead to uncontrolled or undefined restart.
 - ◆ Wherever faults occurring in the control equipment can lead to substantial material damage or even grievous bodily injury (i.e. potentially dangerous faults), additional external precautions must be taken or facilities provided to ensure or enforce safe operation, even when a fault occurs (e.g. independent limit switches, mechanical interlocks, etc.).
 - ◆ Certain parameter settings may cause the inverter to restart automatically after an input power failure.
 - ◆ Motor parameters must be accurately configured for motor overload protection to operate correctly.
 - ◆ This equipment is capable of providing internal motor overload protection in accordance with UL508C section 42. Refer to P0610 and P0335, I²t is ON by default.
 - ◆ This equipment is suitable for use in a circuit capable of delivering not more than 10,000 symmetrical amperes (rms), for a maximum voltage of 115 V/ 230 V when protected by an H, J or K type fuse, a circuit breaker or self-protected combination motor controller.
 - ◆ This equipment must not be used as an 'emergency stop mechanism' (see EN 60204, 9.2.5.4)
-

Repair



WARNING

- ◆ Repairs on equipment may only be carried out by **Siemens Service**, by repair centers **authorized by Siemens** or by qualified personnel who are thoroughly acquainted with all the warnings and operating procedures contained in this manual.
 - ◆ Any defective parts or components must be replaced using genuine Siemens authorised parts.
 - ◆ Risk of electric shock. **Wait 5 minutes for the DC capacitors to discharge before carrying out any installation work.**
-

Dismantling & Disposal

NOTES

- ◆ The inverter's packaging is re-usable. Retain the packaging for future use or return it to the manufacturer.
 - ◆ Easy-to-release screw and snap connectors allow you to break the unit down into its component parts. You can then re-cycle these component parts, dispose of them in **accordance with local requirements or return them to the manufacturer.**
-

Table of Contents

1	Overview	15
1.1	The MICROMASTER 410.....	15
1.2	Features.....	15
2	Installation	17
2.1	General	18
2.2	Power Losses	19
2.3	Ambient operating conditions	19
2.4	Harmonic Currents.....	21
2.5	Derating with Pulse Frequencies	21
2.6	Overvoltage and Trip Levels.....	22
2.7	Mechanical Installation	22
2.8	Electrical Installation	26
3	Commissioning	31
3.1	Block Diagram.....	32
3.2	Commission Modes	33
3.3	General operation	42
4	Using the MICROMASTER 410	45
4.1	Frequency Setpoint (P1000).....	45
4.2	Command Sources (P0700)	46
4.3	OFF and braking Functions	46
4.4	Control Modes (P1300).....	48
4.5	Faults and Alarms	48
5	System Parameters	49
5.1	Introduction to MICROMASTER System Parameters	49
5.2	Parameter Overview	50
5.3	Parameter List (short form).....	51
6	Troubleshooting.....	57
6.1	Troubleshooting with the Standard Inverter LED.....	57
6.2	Troubleshooting with the Operator Panel (OP)	57
6.3	Fault messages.....	58
6.4	Alarms.....	60
7	MICROMASTER 410 Specifications	63

8	Options	67
8.1	Variant Independent Options	67
8.2	Variant Dependent Options	67
9	Electro-Magnetic Compatibility (EMC).....	69
9.1	Electro-Magnetic Compatibility (EMC).....	69
	Appendices	75
A	Fitting the Operator Panel.....	75
B	Applicable Standards	76
C	List of Abbreviations.....	77
Index	78

List of Illustrations

Figure 2-1	Forming	18
Figure 2-2	Power Losses, 230 V	19
Figure 2-3	Derating for Altitude.....	19
Figure 2-4	Dimensions of the MICROMASTER 410	22
Figure 2-5	Clearance distances for mounting the inverter	23
Figure 2-6	Mounting Brackets.....	24
Figure 2-7	Position of 'Y' Capacitor Link.....	28
Figure 2-8	MICROMASTER 410 Connection Terminals.....	28
Figure 2-9	Motor and Power Connections	29
Figure 2-10	Wiring Guidelines to Minimize the Effects of EMI	30
Figure 3-1	Inverter block diagram	32
Figure 3-2	Operator Panel for the MICROMASTER 410 Inverter	33
Figure 3-3	Basic operation.....	34
Figure 3-4	Changing the Line Supply Frequency	35
Figure 3-5	Buttons on the Operator Panel	37
Figure 3-6	Changing parameters via the OP	38
Figure 3-7	Typical Motor Rating Plate Example	41
Figure 3-8	Motor Overload PTC Connection	43
Figure 5-1	Parameter Overview.....	50

List of Tables

Table 2-1	Single Phase 115 V Connection	21
Table 2-2	Single Phase 230 V Connection	21
Table 2-3	Derating with Pulse Frequencies	21
Table 2-4	Trip Levels.....	22
Table 2-5	Dimensions and Torques of MM410.....	23
Table 3-1	Default settings for operation using the standard inverter	34
Table 3-2	Default settings for operation using the OP	36
Table 7-1	MICROMASTER 410 Performance Ratings	63
Table 7-2	Terminal Torques – Field Wiring Connectors	64
Table 7-3	MICROMASTER 410 Specifications	64
Table 9-1	Case 1 - General Industrial.....	71
Table 9-2	Case 2 - Filtered Industrial	71
Table 9-3	Case 3 - Filtered for Residential, Commercial and Light Industry.....	72
Table 9-4	Compliance Table	72

1 Overview

1.1 The MICROMASTER 410

The MICROMASTER 410s are a range of frequency inverters for controlling the speed of three phase AC motors. The various models available range from 120 W to 750 W single-phase input.

The inverters are microprocessor-controlled and use state-of-the-art Insulated Gate Bipolar Transistor (IGBT) technology. This makes them reliable and versatile. A special pulse-width modulation method with selectable pulse frequency permits quiet motor operation. Comprehensive protective functions provide excellent inverter and motor protection.

The MICROMASTER 410 with its default factory settings is ideal for a large range of simple motor control applications.

The MICROMASTER 410 can be used in both 'stand-alone' applications as well as being integrated into 'Automation Systems'.

1.2 Features

Main Characteristics

- Easy installation
- Easy commissioning
- Rugged EMC design
- Can be operated on IT line supplies
- Fast repeatable response time to control signals
- Comprehensive range of parameters enabling configuration for a wide range of applications
- Simple cable connection
- Relay output
- 3 digital inputs
- 1 Analog input - AIN1: 0 – 10 V
The analog input can be used as the 4th digital input
- High pulse frequencies for low-noise motor operation
- Status information and alarm messages with the optional Operator Panel
- External options for PC communications, Operator Panel

Performance Characteristics

- Flux Current Control (FCC) for improved dynamic response and motor control
- Fast Current Limitation (FCL) for trip-free operation
- Built-in DC injection brake
- Compound braking to improve braking performance
- Acceleration/deceleration times with programmable smoothing
- Selectable up and down ramps
- 4-point ramp smoothing
- Multi-point V/f characteristic
- 150 % overload for 60 seconds
- Automatic restart after a mains failure
- Start-on-the-fly

Protection Characteristics

- Overvoltage/undervoltage protection
- Overtemperature protection for the inverter
- Ground fault protection
- Short-circuit protection
- I²t thermal motor protection
- Motor stall prevention

2 Installation



WARNING

- ◆ Work on the device/system by unqualified personnel or failure to comply with warnings can result in severe personal injury or serious damage to material. Only suitably qualified personnel trained in the setup, installation, commissioning and operation of the product should carry out work on the device/system.
- ◆ Only permanently-wired input power connections are allowed. This equipment must be grounded (IEC 536 Class 1, NEC and other applicable standards).
- ◆ If a Residual Current-operated protective Device (RCD) is to be used, it must be an RCD type B.
- ◆ The following terminals can carry dangerous voltages even if the inverter is inoperative:
 - the power supply terminals L and N
 - the motor terminals U, V, W and the terminals DC+ and DC-
- ◆ Always wait 5 minutes to allow the unit to discharge after switching off before carrying out any installation work.
- ◆ This equipment must not be used as an 'emergency stop mechanism' (see EN 60204, 9.2.5.4)
- ◆ The minimum size of the earth-bonding conductor must be equal to or greater than the cross-section of the power supply cables.
- ◆ Safety regulations **must** not be compromised when installing inverters!



CAUTION

The connection of power, motor and control cables to the inverter must be carried out as shown in Figure 2-10 on page 30, to prevent inductive and capacitive interference from affecting the correct functioning of the inverter.

2.1 General

Installation after a Period of Storage

Following a prolonged period of storage, you must reform the capacitors in the inverter. **It is important that the time of storage is calculated from the time of manufacture and not the time of delivery.** The requirements are listed below.

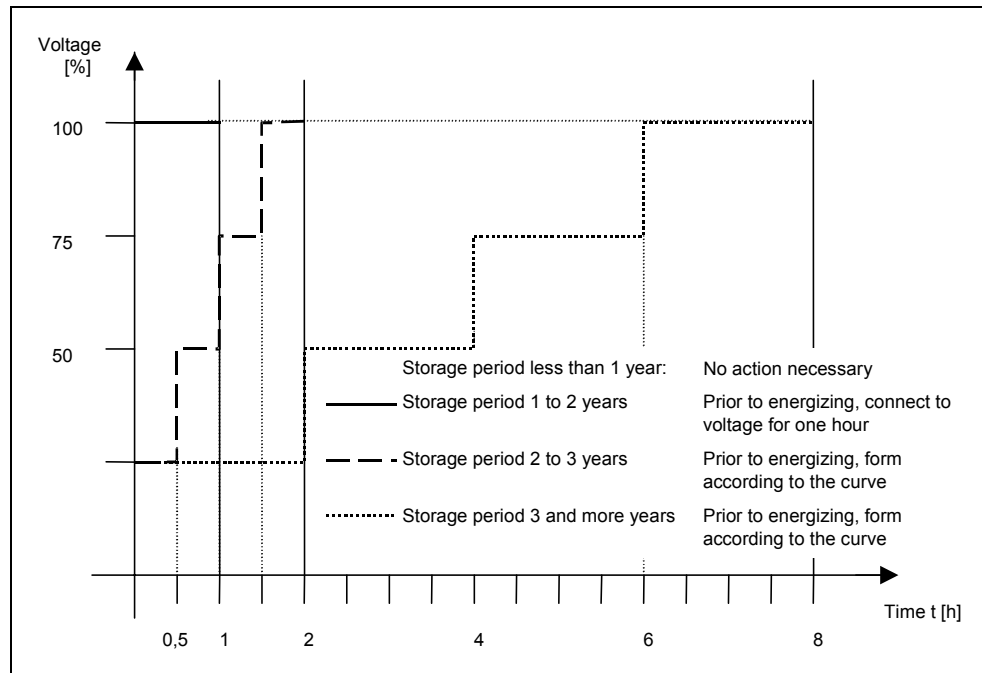

Figure 2-1 Forming

The serial numbers consist 13 characters and contains the date of manufacture, e.g. XAM214-123456

XAM214-123456 Characters 1-2 are the site where the product is built

XAM214-123456 Character 3 denotes the year eg. M = 2000

XAM214-123456 Character 4 is the month (1-9 =Jan-Sep, O =Oct, N =Nov, D =Dec)

XAM214-123456 Characters 5-6 are the day of the month

XAM214-123456 Character 7 is a separator

XAM214-**123456** Characters 8-13 are the sequential serial number 1-999999

2.2 Power Losses

Figure 2-2 shows the power loss for the MICROMASTER 410 Inverter. The graph can be used to read the loss at full load of a particular variant.

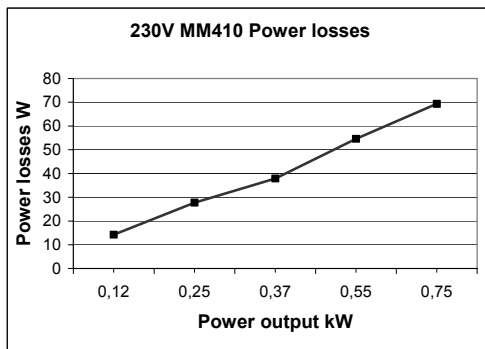

Figure 2-2 Power Losses, 230 V

2.3 Ambient operating conditions

Temperature

Frame Size	AA	AB
Min. [°C]	-10	-10
Max. [°C]	50	50

For UL compliance the maximum surrounding air temperature for 230 V / 750 W and 115 V / 550 W inverters is 40 °C, for all other inverters 50 °C.

Humidity Range

Relative air humidity ≤ 95 % Non-condensing

Altitude

If the inverter is to be installed at an altitude > 1000 m or > 2000 m above sea level, derating will be required.

Figure 2-3 below shows the permissible rated input voltages and output current for inverter installations from 500 m to 4000 m above sea level.

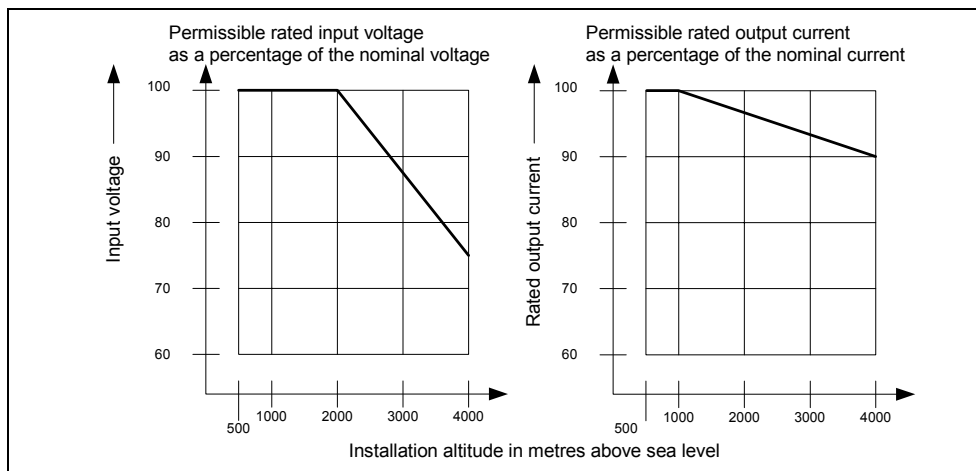

Figure 2-3 Derating for Altitude

Shock

Do not drop the inverter or expose to sudden shock. Do not install the inverter in an area where it is likely to be exposed to constant vibration.

Mechanical strength to EN 60721-3-3

- Deflection: 0.075 mm (10 ... 58 Hz)
- Acceleration: 10 m/s² (58 ... 200 Hz)

Vibration

Do not install the inverter in an area where it is likely to be exposed to constant vibration.

Electromagnetic Radiation

Do not install the inverter near sources of electromagnetic radiation.

Atmospheric Pollution

Do not install the inverter in an environment, which contains atmospheric pollutants such as dust, corrosive gases, etc.

Water

Take care to site the inverter away from potential water hazards, e.g. do not install the inverter beneath pipes that are subject to condensation. Avoid installing the inverter where excessive humidity and condensation may occur.

Installation and cooling

CAUTION

The inverter can be front or side mounted, but **MUST** be installed in a vertical position. Mount the inverter vertically to ensure optimum cooling, see Figure 2-5 on page 23.

Ensure that the inverter's air vents are not obstructed. Allow 100 mm clearance above and below the inverter. A clearance of 30 mm on both sides of the inverter is also required.

2.4 Harmonic Currents

Harmonic currents with 1% mains impedance.

Table 2-1 Single Phase 115 V Connection

MLFB	Filter Type	Power CT (kW)	Fundamental Amps	3 rd Amps	5 th Amps	7 th Amps	9 th Amps	11 th Amps	13 th Amps
6SE6410-2UA11-2AA0	UNFILTERED	0,12	2,90	2,80	2,60	2,35	2,00	1,68	1,30
6SE6410-2UA12-5AA0	UNFILTERED	0,25	5,65	5,30	4,68	3,80	2,87	1,98	1,27
6SE6410-2UA13-7AA0	UNFILTERED	0,37	7,94	7,32	6,07	4,57	3,05	1,87	1,24
6SE6410-2UA15-5BA0	UNFILTERED	0,55	11,25	10,10	8,06	5,67	3,50	2,00	1,58

Table 2-2 Single Phase 230 V Connection

MLFB	Filter Type	Power CT (kW)	Fundamental Amps	3 rd Amps	5 th Amps	7 th Amps	9 th Amps	11 th Amps	13 th Amps
6SE6410-2BB11-2AA0	B	0,12	1,34	1,20	0,83	0,45	0,18	0,12	0,06
6SE6410-2UB11-2AA0	UNFILTERED								
6SE6410-2BB12-5AA0	B	0,25	2,90	2,40	1,70	0,95	0,40	0,20	0,20
6SE6410-2UB12-5AA0	UNFILTERED								
6SE6410-2BB13-7AA0	B	0,37	4,10	3,50	2,50	1,40	0,60	0,25	0,25
6SE6410-2UB13-7AA0	UNFILTERED								
6SE6410-2BB15-5BA0	B	0,55	5,30	4,60	3,30	1,80	0,70	0,40	0,40
6SE6410-2UB15-5BA0	UNFILTERED								
6SE6410-2BB17-5BA0	B	0,75	7,30	6,50	4,40	2,50	1,00	0,50	0,50
6SE6410-2UB17-5BA0	UNFILTERED								

2.5 Derating with Pulse Frequencies

Table 2-3 Derating with Pulse Frequencies

Power (kW)	Measured Output Current (A)						
	4 kHz	6 kHz	8 kHz	10 kHz	12 kHz	14 kHz	16 kHz
0.12	0.9	0.9	0.9	0.8	0.7	0.6	0.5
0.25	1.7	1.7	1.7	1.5	1.3	1.1	0.9
0.37	2.3	2.3	2.3	2.0	1.7	1.5	1.3
0.55 (115V,50°C)	3.0	3.0	2.7	2.5	2.2	2.0	1.7
0.55 (115V,40°C)	3.2	3.2	3.2	2.9	2.6	2.3	2.0
0.75	3.9	3.9	3.6	3.2	2.9	2.6	2.3
0.75 (40° C)	4.2	4.2	4.2	3.8	3.4	3.0	2.7

All currents are rated at 50 °C unless otherwise stated

2.6 Overvoltage and Trip Levels

The inverter will protect itself from both supply overvoltage and undervoltage. Trip levels are shown in Table 2-4. Internal overvoltage can occur during braking where internal voltages are forced high by energy from an external load.

Table 2-4 Trip Levels

Input Supplies	Undervoltage trip levels	Overvoltage trip levels
1 Phase 230 V	115 V	290 V
1 Phase 115 V	60 V	145 V

2.7 Mechanical Installation



Warning

- ◆ **THIS EQUIPMENT MUST BE GROUNDED.**
- ◆ To ensure the safe operation of the equipment, it must be installed and commissioned by qualified personnel in full compliance with the warnings laid down in these operating instructions.
- ◆ Take particular note of the general and regional installation and safety regulations regarding work on dangerous voltage installations (e.g. EN 50178), as well as the relevant regulations regarding the correct use of tools and personal protective equipment (PPE).
- ◆ The mains input, DC and motor terminals, can carry dangerous voltages even if the inverter is inoperative; wait **5 minutes** to allow the unit to discharge after switching off before carrying out any installation work.

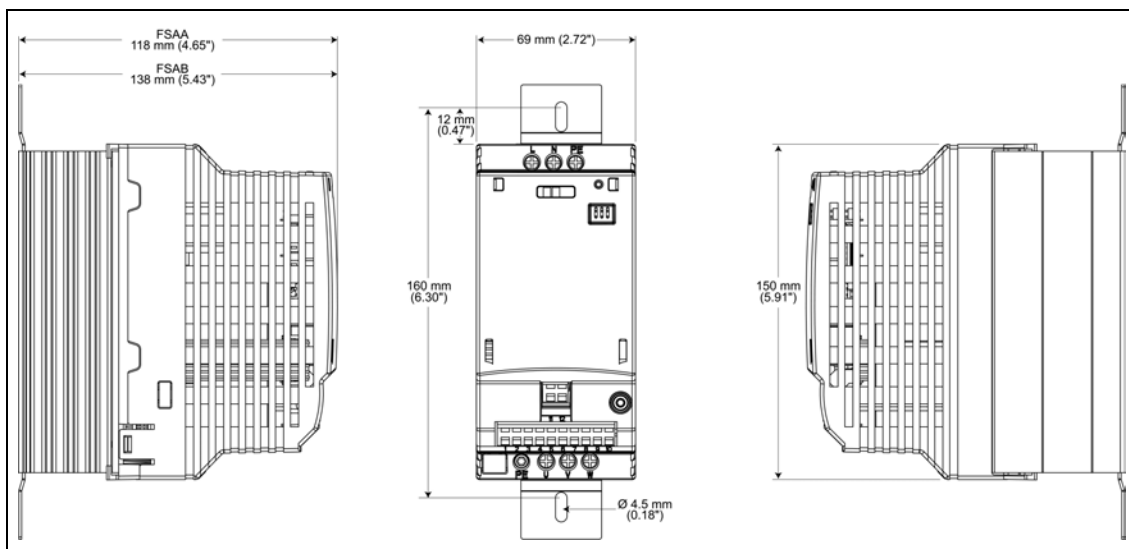

Figure 2-4 Dimensions of the MICROMASTER 410

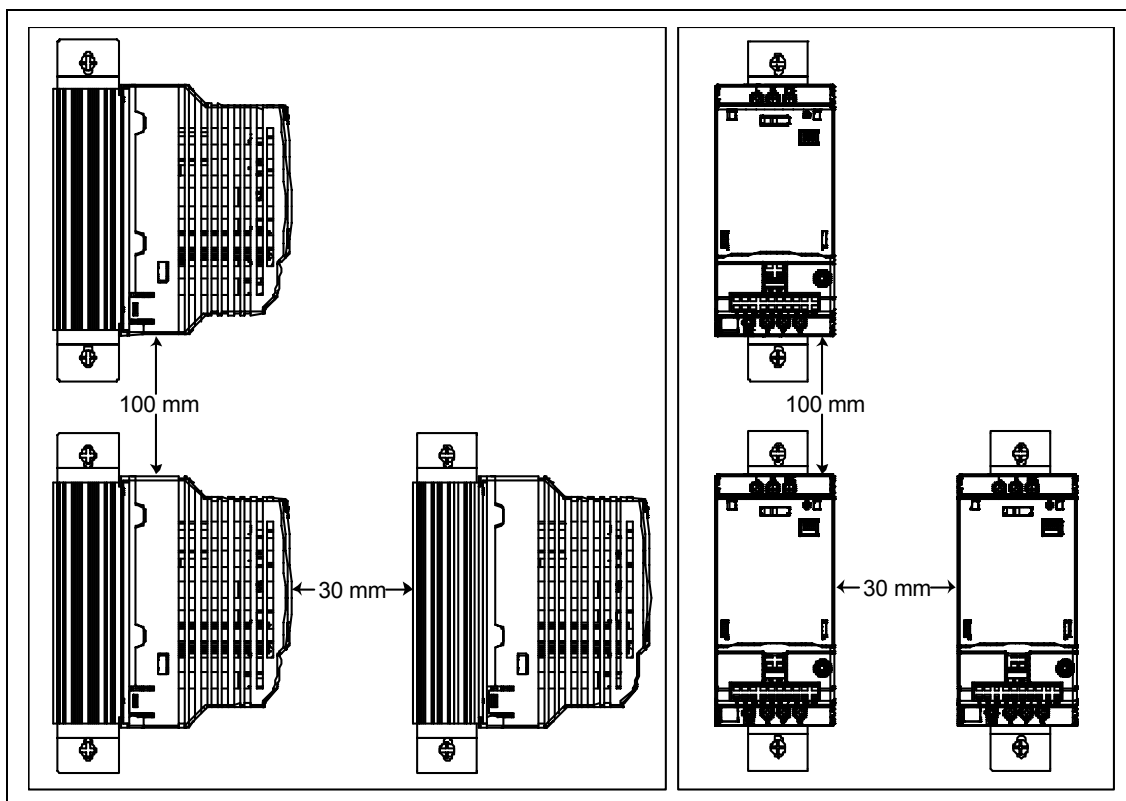

Figure 2-5 Clearance distances for mounting the inverter

For side mounting and UL compliance the ambient temperature should be no greater than 40 °C. The maximum output current of the 750 W inverter is 3.2 A.

Table 2-5 Dimensions and Torques of MM410

Frame Size	Overall Dimensions			Fixing Method	Tightening Torque of fixings
	Height	Width	Depth		
AA	150 mm (5.91")	69 mm (2.72")	118 mm (4.65")	2 x M4 Bolts* 2 x M4 Nuts* 2 x M4 Washers* or Connecting to DIN rail**	2.5 Nm with washers fitted
AB	150 mm (5.91")	69 mm (2.72")	138 mm (5.43")	2 x M4 Bolts* 2 x M4 Nuts* 2 x M4 Washers* or Connecting to DIN rail**	

* Not supplied with the inverter.

** The DIN rail mounting kit is an optional extra which must be ordered separately. For details see Section 2.7.2 on page 25.

2.7.1 Mounting Brackets

The MICROMASTER 410 can be mounted using mounting brackets, which are slotted into the heatsink at the rear of the inverter for normal mounting position (see Figure 2-6 A). For side mounting of the inverter the brackets are slotted into the heatsink as shown in Figure 2-6 B.

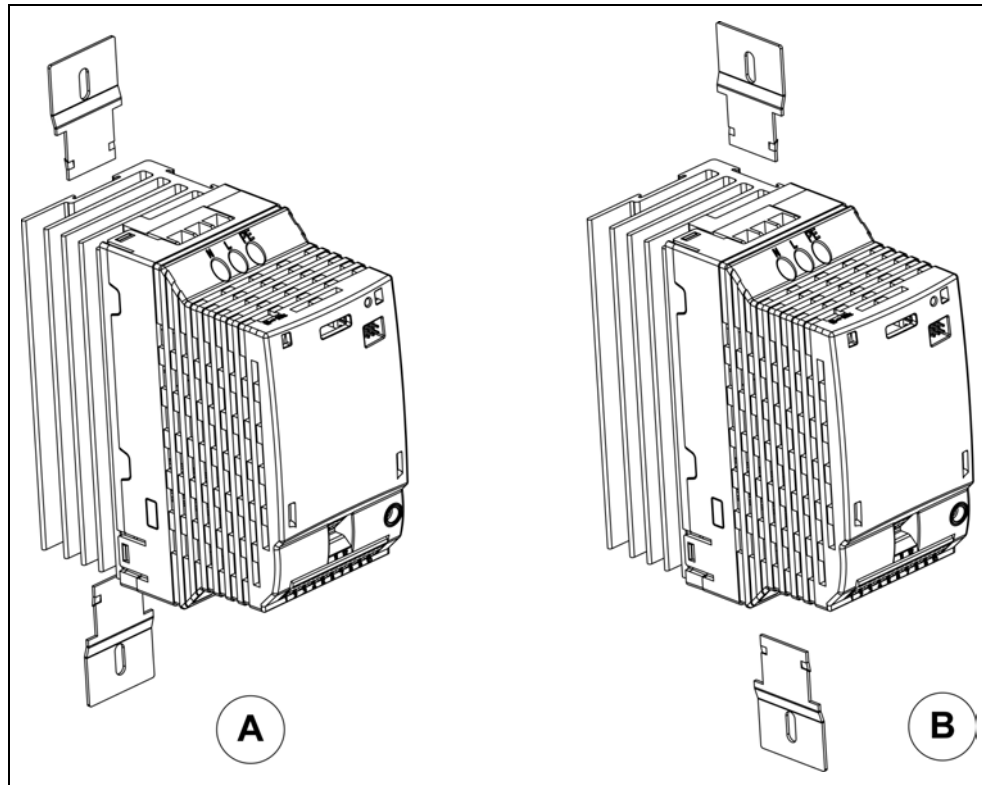

Figure 2-6 Mounting Brackets

2.7.2 DIN Rail Mounting

The DIN Rail Mounting Kit consists of the following items:

- 1 x plastic moulded base
- 1 x plastic moulded retaining clip
- 1 x Metal spring

The DIN Rail Mounting Kit is supplied as an option for the inverter. If a mounting kit is required it can be ordered using the following order number:

- 6SE6400-0DR00-0AA0

In order to fit the DIN Rail Mounting Kit to the inverter, the kit must first be assembled using the following procedure:

1. The retaining clip is fitted into the recess of the plastic moulded base, as shown in Drawing A.
2. The spring is fitted into the base as shown in Drawing B.
3. Ensure that the spring is secured to the retaining clip as shown in Drawing B.
4. Ensure that the retaining clip can be moved in a downward direction, as shown in Drawing C.
When the retaining clip is released, it should return to its normal position in an upward direction. If it does not, the spring has been fitted incorrectly.

In order to fit the DIN Rail Mounting Kit to the inverter the following procedure should be performed:

1. The base is fitted to the inverter using 2 x M5 screws, as shown in Drawing D.
2. Ensure that the base is securely fastened to the inverter without causing any damage to the moulded plastic base.

Ensure that the base is securely fastened to the inverter without causing any damage to the moulded plastic base.

1. Clip the top recess of the base onto the DIN rail, as shown in Drawing E.
2. The inverter can now be pushed and locked onto the DIN rail.

The inverter can be removed from the DIN rail by pulling the retaining clip in a downward direction.

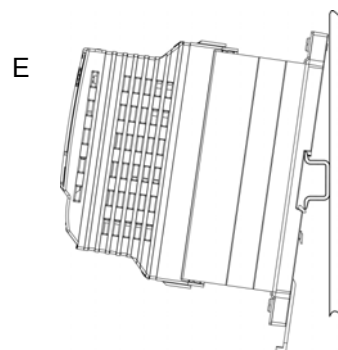
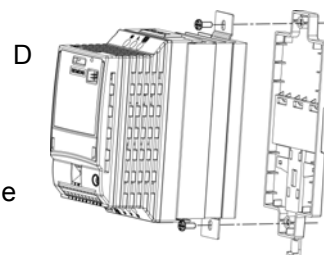
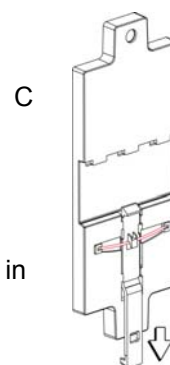
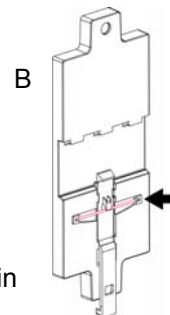
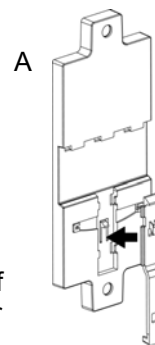

2.8 Electrical Installation



WARNING

THIS EQUIPMENT MUST BE GROUNDED.

- ◆ To ensure the safe operation of the equipment, it must be installed and commissioned by qualified personnel in full compliance with the warnings laid down in these operating instructions.
 - ◆ Take particular note of the general and regional installation and safety regulations regarding work on dangerous voltage installations (e.g. EN 50178), as well as the relevant regulations regarding the correct use of tools and personal protective gear.
 - ◆ The mains input, DC and motor terminals, can carry dangerous voltages even if the inverter is inoperative; wait **5 minutes** to allow the unit to discharge after switching off before carrying out any installation work.
 - ◆ The inverters can be installed in a side-by-side configuration with a minimum distance of 30 mm (1.18 inches) between units and a distance of 100 mm (3.94 inches) must be maintained if the inverters are installed on top of each other.
-



CAUTION

The control, power supply and motor leads **must** be laid separately. Do not feed them through the same cable conduit/trunking. Never use high voltage insulation test equipment on cables connected to the inverter.

2.8.1 General



WARNING

The inverter must always be grounded.

If the inverter is not grounded correctly, extremely dangerous conditions may arise within the inverter, which could prove potentially fatal.

Operation with ungrounded (IT) supplies

The MICROMASTER will operate from ungrounded supplies and will continue to operate if an output phase is shorted to ground.

On ungrounded supplies, it will be necessary to cut the 'Y' capacitor link from the inside of the unit. The procedure for removing this capacitor is described on page 28 (Figure 2-7) of this manual.

Operation with Residual Current Device

If an RCD (also referred to as ELCB or RCCB) is fitted, the MICROMASTER inverters will operate without nuisance tripping, provided that:

- ☑ A type B RCD is used.
- ☑ The trip limit of the RCD is 30 mA.
- ☑ The neutral of the supply is grounded.
- ☑ Only one inverter is supplied from each RCD.
- ☑ The output cables are less than 30 m [98.43 ft](screened) or 50 m [164.04 ft] (unscreened).

Operation with long cables

All inverters will operate at full specification with cable lengths up to 30 m [98.43 ft] (screened) or 50 m [164.04 ft] (unscreened).

2.8.2 Power and motor connections



WARNING

- ◆ Isolate the mains electrical supply before making or changing connections to the unit.
 - ◆ Ensure that the inverter is configured for the correct supply voltage: single-phase 230 V MM410 MICROMASTERS must not be connected to a higher voltage supply.
 - ◆ The 115 V unit MUST only be connected to a 115 V supply.
 - ◆ When synchronous motors are connected or when connecting several motors in parallel, the inverter must be operated with voltage/frequency control characteristic (P1300 = 0, 2 or 3).
-

NOTICE

- ◆ Ensure that the appropriate circuit-breakers/fuses with the specified current rating are connected between the power supply and inverter (*see Tables starting on page 63*).
 - ◆ Use Class 1 60/75°C copper wire only (16 AWG minimum for UL compliance). For 115 V units use class 1 75 °C copper wire only. For tightening torque see Table 7-2 on page 64.
 - ◆ To tighten up the power terminal screws use a 4 - 5 mm cross-tip screwdriver.
-

Removal of ‘Y’ Capacitor Link

To use the inverter on ungrounded supplies the ‘Y’ capacitor (cap) link must be removed as follows:

1. Ensure the inverter has been disconnected from all power supplies.
2. Locate the ‘Y’ Cap cover on the left side of the unit near the rating label.
3. Carefully remove the ‘Y’ Cap cover.
4. Cut the ‘Y’ Cap link with an appropriate pair of wire-cutters.
5. After removal of the cover the degree of protection is IP00.

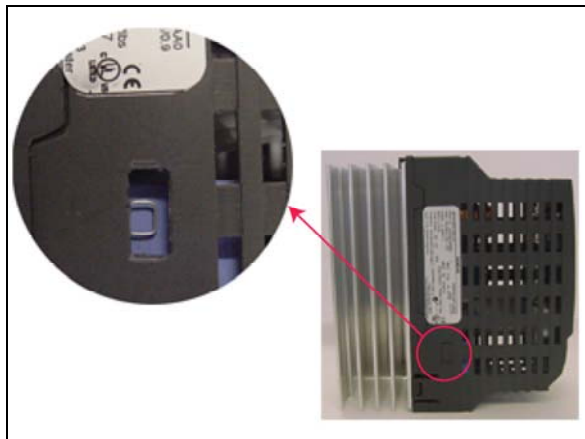

Figure 2-7 Position of ‘Y’ Capacitor Link

Access to the power and motor terminals

Please refer to the photographs showing the Power Terminal connections and the Control Terminal connections on the inside of the back cover of this manual.

Connect the power and motor connections as shown below.

For access to the DC+/DC- terminals the cut-out cover must be removed. The terminal connection consists of two spades measuring 6.3 mm by 0.8 mm. With the cut-out cover removed and not connections fitted to the spades, the inverter has only IP00 protection.

The connection of the DC link can be used for two inverters, with two motors which work on a revolving advertising media or similar application:

one inverter is in motor mode and the other is in regenerative mode.

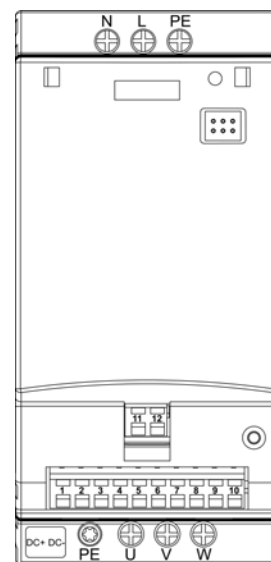

Figure 2-8 MICROMASTER 410 Connection Terminals

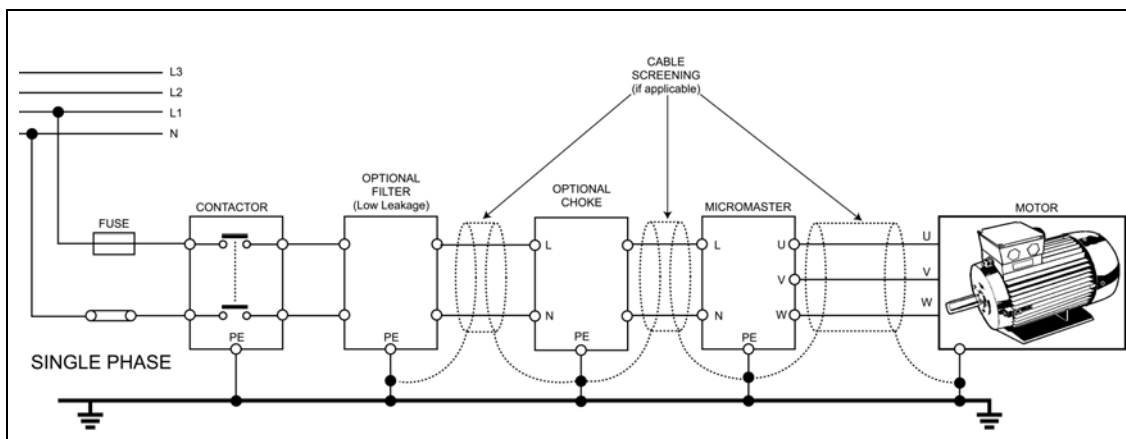

Figure 2-9 Motor and Power Connections

2.8.3 Avoiding Electro-Magnetic Interference (EMI)

The inverters are designed to operate in an industrial environment where a high level of EMI can be expected. Usually, good installation practices will ensure safe and trouble-free operation. If you encounter problems, follow the guidelines stated below.

Action to Take

- Ensure that all equipment in the cubicle is well grounded using short, thick grounding cable connected to a common star point or busbar.
- Make sure that any control equipment (such as a PLC) connected to the inverter is connected to the same ground or star point as the inverter via a short thick link.
- Connect the return ground from the motors controlled by the inverters directly to the ground connection (PE) on the associated inverter.
- Flat grounding conductors are preferred as they have lower impedance at higher frequencies.
- Terminate the ends of the cable neatly, ensuring that unscreened wires are as short as possible.
- Separate the control cables from the power cables as much as possible, using separate trunking, cross them if necessary at 90° to each other.
- Whenever possible, use screened leads for the connections to the control circuitry.
- Ensure that the contactors in the cubicle are suppressed, either with R-C suppressors for AC contactors or 'flywheel' diodes for DC contactors fitted to the coils. Varistor suppressors are also effective. This is important when the contactors are controlled from the inverter relay.
- Use screened or armored cables for the motor connections and ground the screen at both ends using the cable clamps.

The inverter can be screened using the methodology shown in Figure 2-10.

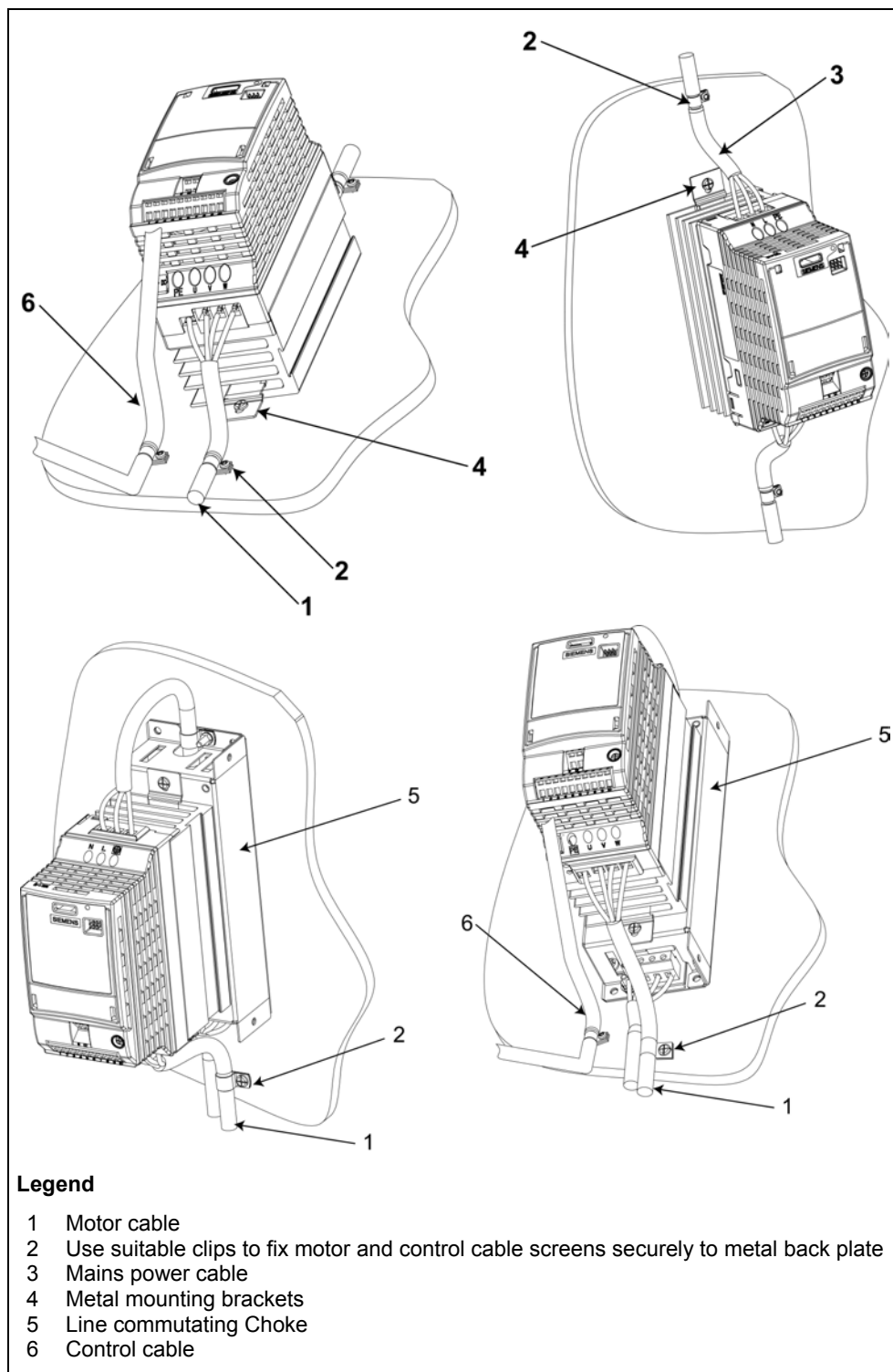

Figure 2-10 Wiring Guidelines to Minimize the Effects of EMI

3 Commissioning



WARNING

- ◆ MICROMASTERS operate at high voltages.
 - ◆ When operating electrical devices, it is impossible to avoid applying hazardous voltages to certain parts of the equipment.
 - ◆ Emergency Stop facilities according to EN 60204 IEC 204 (VDE 0113) must remain operative in all operating modes of the control equipment. Any disengagement of the Emergency Stop facility must not lead to uncontrolled or undefined restart.
 - ◆ Wherever faults occurring in the control equipment can lead to substantial material damage or even grievous bodily injury (i.e. potentially dangerous faults), additional external precautions must be taken or facilities provided to ensure or enforce safe operation, even when a fault occurs (e.g. independent limit switches, mechanical interlocks, etc.).
 - ◆ Certain parameter settings may cause the inverter to restart automatically after an input power failure.
 - ◆ Motor parameters must be accurately configured for motor overload protection to operate correctly.
 - ◆ This equipment is capable of providing internal motor overload protection in accordance with UL508C section 42. Refer to P0610 and P0335, I²t is ON by default.
 - ◆ This equipment is suitable for use in a circuit capable of delivering not more than 10,000 symmetrical amperes (rms), for a maximum voltage of 115 V/230 V when protected by an H, J or K type fuse, a circuit breaker or self-protected combination motor controller.
 - ◆ This equipment **must** not be used as an 'emergency stop mechanism' (see EN 60204, 9.2.5.4)
-



CAUTION

Only qualified personnel may enter settings in the control panels. Particular attention must be paid to safety precautions and warnings at all times.

3.1 Block Diagram

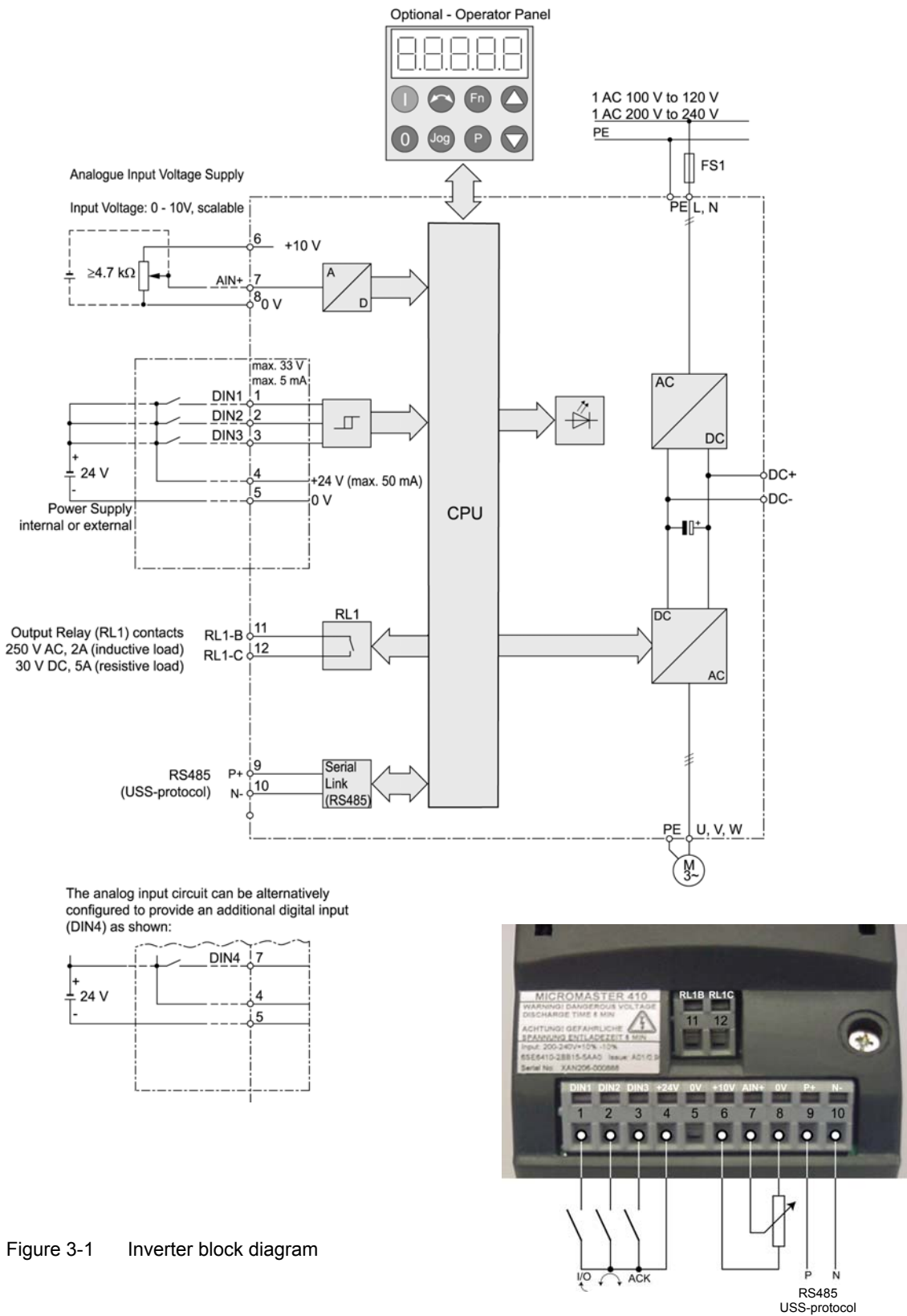

Figure 3-1 Inverter block diagram

3.2 Commission Modes

The MICROMASTER 410 is supplied with default parameter settings cover the following:

- The motor rating data; voltage, current and frequency data is keyed into the inverter to ensure that the motor is compatible with the inverter. (A standard Siemens motor is recommended).
- Linear V/f motor speed, controlled by an analogue potentiometer.
- Maximum speed 3000 min⁻¹ with 50 Hz (3600 min⁻¹ with 60 Hz); controllable using a potentiometer via the inverter's analogue inputs.
- Ramp-up time / Ramp-down time = 10 s.

If more complex application settings are required, please refer to the Parameter List.

Front Panels for the MICROMASTER 410

For instructions on how to exchange/replace the Operator Panels, please refer to the appropriate Appendix A in this manual.

To change the parameters of the inverter you will require the optional Operator Panel. To assist in the quick and efficient changing of parameters, commissioning software tools such as DriveMonitor can be used; this software is supplied on the CD-ROM and can also be downloaded from the Internet.

To allow the parameters to be changed using the software tools, the PC to Inverter Connection Kit is required.



Operator Panel
(Option)

Figure 3-2 Operator Panel for the
MICROMASTER 410
Inverter

3.2.1 Commissioning without an Operator Panel

The inverter is supplied with an LED to indicate the operation state of the unit.

The inverter can be used with its default settings, for a number of applications. The default settings are shown in Table 3-1.

The terminal layout is shown in the photograph of the Control Terminal Connections on the inside of the back cover of this manual.

Table 3-1 Default settings for operation using the standard inverter

	Terminals	Parameter Default	Default Operation
Digital Input 1	1	P0701 = '1'	ON/OFF1
Digital Input 2	2	P0702 = '12'	Reverse
Digital Input 3	3	P0703 = '9'	Fault Acknowledge

Warnings and faults states on the Inverter

The LED indicates the operating status of the inverter. The LED also indicate various warnings or fault states. In section 6.1 on page 57 the inverter states, indicated by the LED are explained.

3.2.2 Basic operation

With the default settings of the inverter the following is possible:

- Start and stopping the motor (DIN1 via external switch)
- Reversing the motor (DIN2 via external switch)
- Fault Acknowledgement (DIN3 via external switch)

Controlling the speed of the motor is accomplished by connecting the analog inputs as shown in the Figure 3-3 (Switches and potentiometers are not supplied with the inverter).

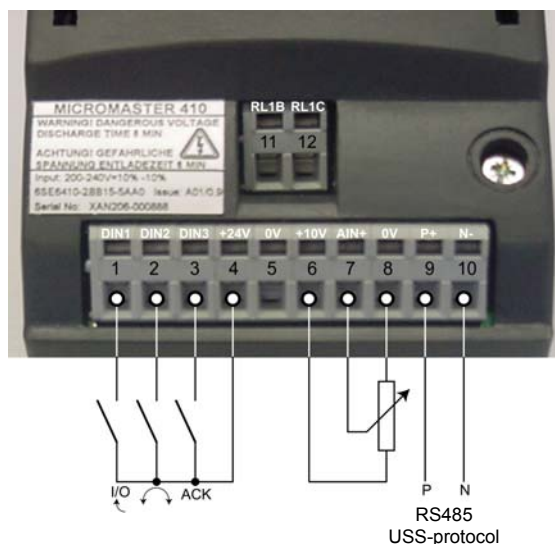

Figure 3-3 Basic operation

3.2.3 Changing the Line Supply Frequency

The supply frequency of the inverter can be changed using either the Operator Panel or by physically cutting the Supply Frequency Link as shown in Figure 3-4:

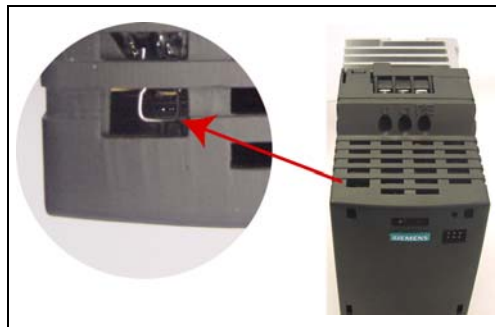

Figure 3-4 Changing the Line Supply Frequency

Cutting the supply link

The line supply frequency can be set by cutting the supply link (see inset)

1. Ensure inverter is disconnected from power supply.
2. Carefully cut the link with an appropriate pair of wire-cutters.
3. Inverter is now set for 60 Hz.

The inverter can be set back to 50 Hz, by setting P0100 = 0.

Using the Operator Panel

The supply frequency can be set by the following parameters:

- Set P0100 = 0 (50 Hz) default
- Set P0100 = 1 (60 Hz)

3.2.4 Commissioning Overview with the optional Operator Panel

Prerequisites

Mechanical and electrical Installation are completed.

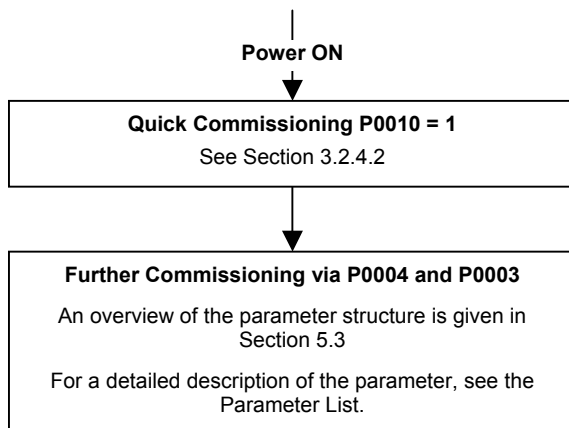

NOTE

We recommend the commissioning according this scheme. Nevertheless an expert user is allowed to do the commissioning without the filter functions of P0004.

3.2.4.1 Commissioning with the Operator Panel



The Operator Panel (OP) provides access to the inverter parameters and enables the user to customize the settings of your MICROMASTER 410. The OP can be used to configure several MICROMASTER 410 Inverters. This is accomplished by using the OP to set the required parameters and once the process is complete, then the OP can be removed.

The OP contains a five-digit display that allows the user to read and change parameter values. The OP does not have the capability to store parameter information.

Table 3-2 shows the factory default settings for operation via the Operator Panel.

Notes

- ◆ The OP motor control functions are disabled by default. To control the motor via the OP, parameter P0700 should be set to 1 and P1000 set to 1.
- ◆ The OP can be fitted to and removed from the inverter whilst power is applied.
- ◆ If the OP has been set as the I/O control (P0700 = 1), the drive will stop if the OP is removed.

Table 3-2 Default settings for operation using the OP

Parameter	Meaning	Default
P0100	Operating Mode Europe/US	50 Hz, kW
P0307	Power (rated motor)	Dimension (kW (Hp)) depending on setting of P0100. [default value depending on variant.]
P0310	Motor frequency rating	50 Hz (60 Hz) depending on setting of P0100.
P0311	Motor speed rating	1395 (1680) rpm; depending on setting of P0100. [default value depending on variant]
P1082	Maximum Motor Frequency	50 Hz (60 Hz) depending on setting of P0100.

Buttons on the Operator Panel















Panel/Button	Function	Effects
	Indicates Status	The LCD displays the settings currently used by the converter.
	Start motor	Pressing the button starts the converter. This button is disabled by default. To enable this button set P0700 = 1.
	Stop motor	OFF1 Pressing the button causes the motor to come to a standstill at the selected ramp down rate. Disabled by default; to enable set P0700 = 1. OFF2 Pressing the button twice (or once long) causes the motor to coast to a standstill. This function is always enabled.
	Change direction	Press this button to change the direction of rotation of the motor. Reverse is indicated by a minus (-) sign or a flashing decimal point. Disabled by default, to enable set P0700 = 1.
	Jog motor	Pressing this button while the inverter has no ON command causes the motor to start and run at the preset jog frequency. The motor stops when the button is released. Pressing this button when the motor is running has no effect.
	Functions	This button can be used to view additional information. Pressing and holding the button for 2 seconds from any parameter during operation, shows the following: 1. DC link voltage (indicated by d – units V). 2. Output frequency (Hz) 3. Output voltage (indicated by o – units V). 4. The value selected in P0005 Additional presses will toggle around the above displays. A short press of the button will acknowledge a fault condition. Jump Function From any parameter (rXXXX or PXXXX) a short press of the Fn button will immediately jump to r0000, you can then change another parameter, if required. Upon returning to r0000, pressing the Fn button will return you to your starting point.
	Access parameters	Pressing this button allows access to the parameters.
	Increase value	Pressing this button increases the displayed value.
	Decrease value	Pressing this button decreases the displayed value.

Figure 3-5 Buttons on the Operator Panel

Changing parameters with the Operator Panel

The procedure for changing the value of parameter P0004 is described below. Modifying the value of an indexed parameter is illustrated using the example of P2011. Follow exactly the same procedure to alter other parameters that you wish to set via the OP.

Changing P0004 – parameter filter function

Step	Result on display
1 Press  to access parameters	r0000
2 Press  until P0004 is displayed	P0004
3 Press  to access the parameter value level	0
4 Press  or  to the required value	3
5 Press  to confirm and store the value	P0004
6 Only the motor parameters are visible to the user.	

Changing P2011 an indexed parameter Setting USS address









Step	Result on display
1 Press  to access parameters	r0000
2 Press  until P2011 is displayed	^{P(2)} P2011
3 Press  to access the parameter value level	^{P(2)} r0000
4 Press  to display current set value	^{P(2)} 0
5 Press  or  to the required value	^{P(2)} 3
6 Press  to confirm and store the value	^{P(2)} P2011
7 Press  until r0000 is displayed	r0000
8 Press  to return the display to the standard drive display (as defined by the customer)	

Figure 3-6 Changing parameters via the OP





NOTE

In some cases - when changing parameter values - the display on the Operator Panel shows **busy**. This means the inverter is busy with tasks of higher priority.

Changing single digits in Parameter values

For changing the parameter value rapidly, the single digits of the display can be changed by performing the following actions:

Ensure you are in the parameter value changing level (see "Changing parameters with Operator Panel").

1. Press  (function button), which causes the right hand digit to blink.
 2. Change the value of this digit by pressing  / .
 3. Press  (function button) again causes the next digit to blink.
 4. Perform steps 2 to 4 until the required value is displayed.
 5. Press the  to leave the parameter value changing level.
-

NOTE

The function button may also be used to acknowledge a fault condition

3.2.4.2 Quick commissioning (P0010=1)

It is **important** that parameter P0010 is used for commissioning and P0003 is used to select the number of parameters to be accessed. This parameter allows a group of parameters to be selected that will enable quick commissioning. Parameters such as Motor settings and Ramp settings are included.

At the end of the quick commissioning sequence, P3900 should be selected, which, when set to 1, will carry out the necessary motor calculations and clear all other parameters (not included in P0010=1) to the default settings. This will only happen in the Quick Commissioning mode.

Flow chart Quick Commissioning (Level 1 Only)

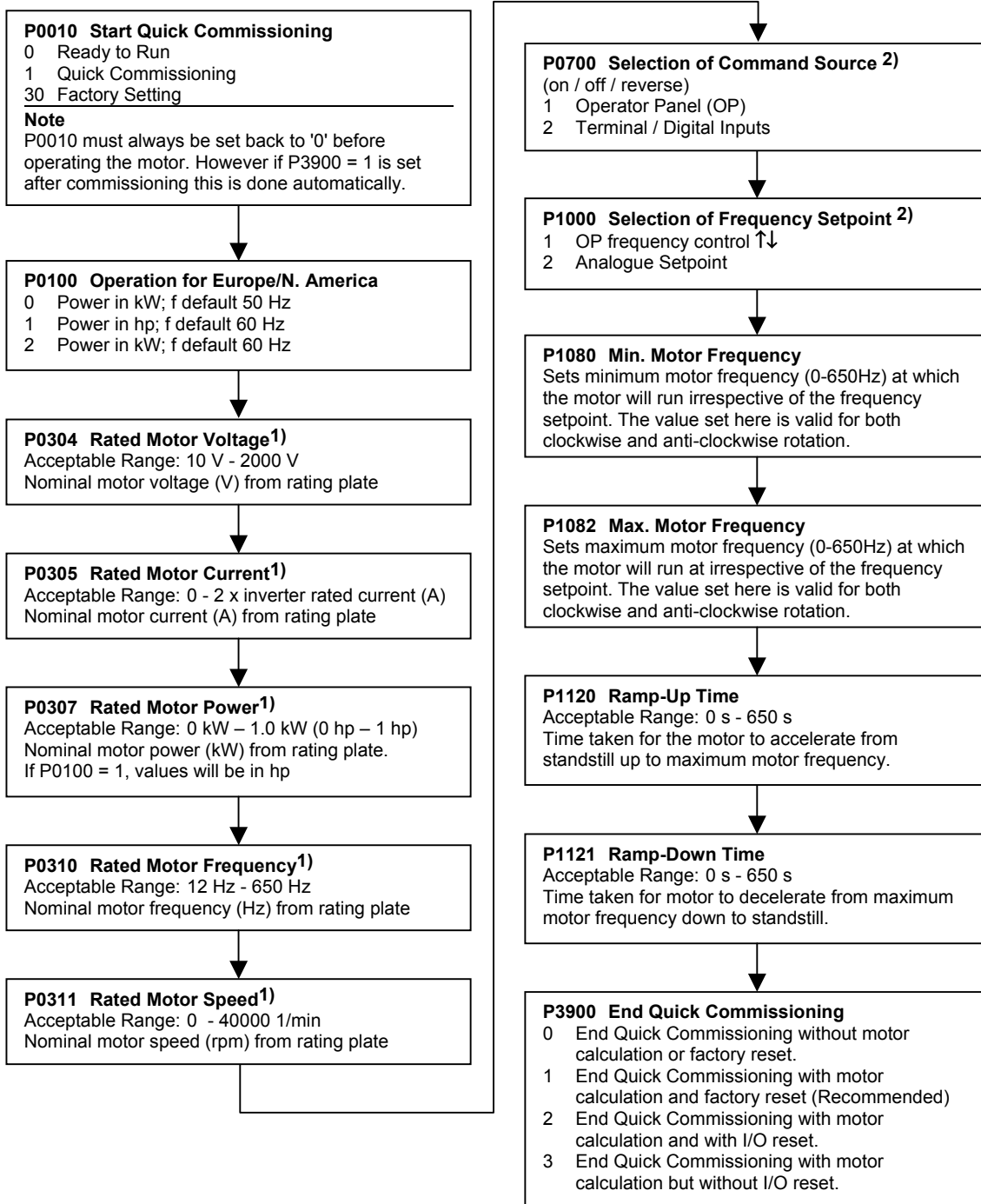

1) Motor related parameters – please refer to motor rating plate.

2) Denotes parameters that contain more detailed lists of possible settings for use in specific applications. Please refer to the Parameter List

Motor data for parameterization

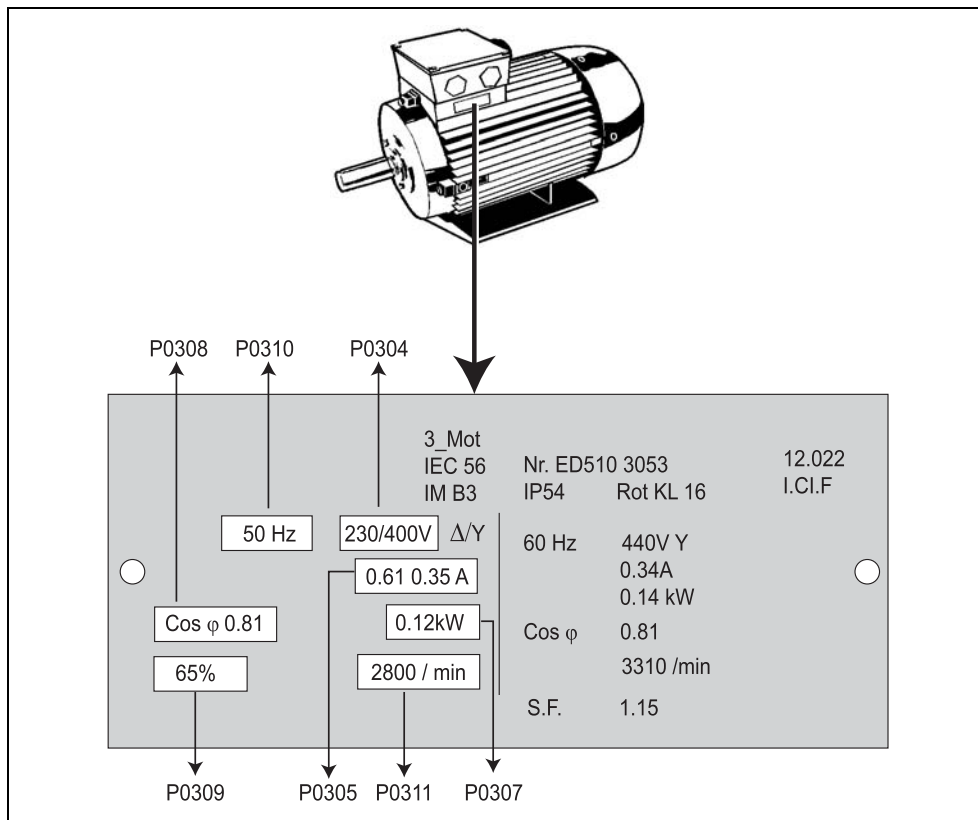

Figure 3-7 Typical Motor Rating Plate Example

NOTE

- P0308 & P0309 are only visible if P0003 = 3. Only one of the parameters is shown depending on the settings of P0100.
- P0307 indicates kW or hp depending upon the setting of P0100. For detailed information, please see the Parameter List.
- Changing motor parameters is not possible unless P0010 = 1.
- Ensure that the motor is configured correctly to the inverter (star/delta connection).

3.2.4.3 Reset to Factory default

To reset all parameters to the factory default settings; the following parameters should be set as follows (the operator panel option is required):

1. Set P0010 = 30
2. Set P0970 = 1

NOTE

The reset process can take up to 3 minutes to complete.

3.3 General operation

For a full description of Level 1 to Level 3 parameters, please refer to the Parameter List.

NOTICE

1. The inverter does not have a main power switch and is live when the mains supply is connected. It waits, with the output disabled, until the RUN button is pressed or for the presence of a digital ON signal at terminal 1.
 2. If an OP is fitted and the output frequency is selected to be displayed (P0005 = 21) the corresponding setpoint is displayed approximately every 1.0 seconds while the inverter is stopped.
 3. The inverter is programmed at the factory for standard applications on Siemens four-pole standard motors that have the same power rating as the inverters. When using other motors it is necessary to enter the specifications from the motor's rating plate. See Figure 3-7 for details on how to read motor data.
 4. Changing motor parameters is not possible unless P0010 = 1.
 5. You must set P0010 back to 0 in order to initiate a run.
-





Basic operation with the OP

Prerequisites

P0010 = 0 (in order to initiate the run command correctly).

P0700 = 1 (enables the start/stop button on the OP).

P1000 = 1 (this enables the motor potentiometer setpoints).

1. Press the green Button  to start the motor.
2. Press the Button  while the motor is turning. Motor speed increases to 50 Hz.
3. When the inverter reaches 50 Hz, press the Button . Motor speed and displayed value are decreased.
4. Change the direction of rotation with the Button .
5. The red button stops the motor .

External motor thermal overload protection

When operated below rated speed, the cooling effect of fans fitted to the motor shaft is reduced. Consequentially, most motors require de-rating for continuous operation at low frequencies. To ensure that the motors are protected against overheating under these conditions, a PTC temperature sensor must be fitted to the motor and connected to the inverter control terminals as shown in Figure 3-8.

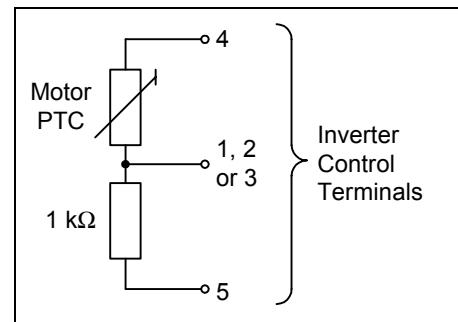

Figure 3-8 Motor Overload PTC Connection

NOTE

To enable the trip function, set parameter P0701, P0702 or P0703 = 29.

4 Using the MICROMASTER 410



WARNING

- ◆ When operating electrical devices, it is impossible to avoid applying hazardous voltages to certain parts of the equipment.
- ◆ Emergency Stop facilities according to EN 60204 IEC 204 (VDE 0113) must remain operative in all operating modes of the control equipment. Any disengagement of the Emergency Stop facility must not lead to uncontrolled or undefined restart.
- ◆ Wherever faults occurring in the control equipment can lead to substantial material damage or even grievous bodily injury (i.e. potentially dangerous faults), additional external precautions must be taken or facilities provided to ensure or enforce safe operation, even when a fault occurs (e.g. independent limit switches, mechanical interlocks, etc.).
- ◆ MICROMASTERS operate at high voltages.
- ◆ Certain parameter settings may cause the inverter to restart automatically after an input power failure.
- ◆ Motor parameters must be accurately configured for motor overload protection to operate correctly.
- ◆ This equipment is capable of providing internal motor overload protection in accordance with UL508C section 42. Refer to P0610 and P0335, I²t is ON by default.
- ◆ This equipment is suitable for use in a circuit capable of delivering not more than 10,000 symmetrical amperes (rms), for a maximum voltage of 115 V/230 V when protected by an H, J or K type fuse, a circuit breaker or self-protected combination motor controller.
- ◆ This equipment **must** not be used as an 'emergency stop mechanism' (see EN 60204, 9.2.5.4)

4.1 Frequency Setpoint (P1000)

- Default: Terminal 7 (AIN, 0...10 V corresponds to 0...50/60 Hz)
- Other settings: see P1000

4.2 Command Sources (P0700)

NOTICE

The ramp times and ramp-smoothing functions also affect how the motor starts and stops. For details of these functions, please refer to parameters P1120, P1121, P1130 – P1134 in the Parameter List.

Starting the motor

- Default: Terminal 1 (DIN 1, high)
- Other settings: see P0700 to P0704

Stopping the motor

There are several ways to stop the motor:

- Default:
 - ◆ OFF1 Terminal 1 (DIN 1, low)
 - ◆ OFF2 Off button on Operator Panel, pressing the Off button once long (two seconds) or twice (with default settings)
 - ◆ OFF3 no standard setting
- Other settings: see P0700 to P0704

Reversing the motor

- Default: Terminal 2 (DIN 2, high)
- Other settings: see P0700 to P0704

4.3 OFF and braking Functions

4.3.1 OFF1

This command (produced by canceling the ON command) causes the inverter to come to a standstill at the selected ramp-down rate.

Parameter to change ramp-down time see P1121

NOTICE

- ON and the following OFF1 command must have the same source.
 - If the ON/OFF1 command is set to more than one digital input, only the last set digital input is valid e.g. DIN3 is active.
 - OFF1 can be combined with DC braking or Compound braking.
-

4.3.2 OFF2

This command causes the motor to coast to a standstill (pulses disabled).

NOTICE

The OFF2 command can have one or more sources. By default the OFF2 command is set to Operator Panel. This source still exists even if other sources are defined by **one** of the following parameters, P0700 to P0704 inclusive.

4.3.3 OFF3

An OFF3 command causes the motor to decelerate rapidly.

If a digital input is used as a source for OFF3, the digital input has to be closed (high) in order to start the motor. If OFF3 is high, the motor can be started resp. stopped by re-setting OFF1 or OFF2.

If OFF3 is low the motor cannot be started.

➤ Ramp down time: see P1135

NOTICE

OFF3 can be combined with DC braking or Compound braking.

4.3.4 DC braking

DC braking is possible together with OFF1 and OFF3. A DC current is applied to stop the motor quickly and hold the shaft stationary after the end of the braking period.

- Enable DC braking: see P0701 to P0704
- Set DC braking period: see P1233
- Set DC braking current: see P1232

NOTICE

If no digital input is set to DC braking and P1233 \neq 0, DC braking will be active after every OFF1 command with the time set in P1233.

4.3.5 Compound Braking

Compound Braking is possible with both OFF1 and OFF3. For Compound Braking a DC component is added to the AC current.

Set the braking current: see P1236

4.4 Control Modes (P1300)

The various modes of operation of the MICROMASTER 410 control the relationship between the speed of the motor and the voltage supplied by the inverter. A summary of the control modes available are listed below:

- **Linear V/f control,** **P1300 = 0**
Can be used for variable and constant torque applications, such as conveyors and positive displacement pumps.
- **Linear V/f control with FCC (Flux Current Control),** **P1300 = 1**
This control mode can be used to improve the efficiency and dynamic response of the motor.
- **Quadratic V/f control** **P1300 = 2**
This mode can be used for variable torque loads, such as fans and pumps.
- **Multi-point V/f control** **P1300 = 3**
For information regarding this mode of operation, please consult the MM410 Parameter List.

4.5 Faults and Alarms

Standard Inverter

If an Operator Panel is not fitted, the fault states and warnings are indicated by the LED on the panel, see section 6.1 on page 57 for further information.

If the inverter is working correctly, the following LED sequence is visible:

- Flashing Yellow (1000 ms on / 1000 ms off) = Ready to run
- Continuous Yellow = Run

Operator Panel Fitted

If an Operator Panel is fitted, the fault states (P0947) and warnings (P2110) are displayed should a fault condition occur. For further details, please refer to the Parameter List.

5 System Parameters

5.1 Introduction to MICROMASTER System Parameters

The parameters can only be changed by using the Operator Panel (OP) or the Serial Interface.

Parameters can be changed and set using the OP to adjust the desired properties of the inverter, such as ramp times, minimum and maximum frequencies etc. The parameter numbers selected and the setting of the parameter values are indicated on the optional five-digit LCD display.

- rxxxx indicates a display parameter, Pxxxx a setting parameter.
- P0010 initiates “quick commissioning”.
- The inverter will not run unless P0010 is set to 0 after it has been accessed. This function is automatically performed if P3900 > 0.
- P0004 acts as a filter, allowing access to parameters according to their functionality.
- If an attempt is made to change a parameter that cannot be changed in this status, for example, cannot be changed whilst running or can only be changed in quick commissioning, then `-----` will be displayed.
- **Busy Message**
In some cases - when changing parameter values - the display on the OP shows `busy` for maximum of five seconds. This means the inverter is busy with tasks of higher priority.

5.1.1 Access Levels

There are three access levels available to the user; Standard, Extended and Expert. The level of access is set by parameter P0003. For most applications, the Standard and Extended levels are sufficient.

The number of parameters that appear within each functional group (selected by P0004) depends on the access level set in parameter P0003. For further details regarding parameters, see the Parameter List.

5.2 Parameter Overview

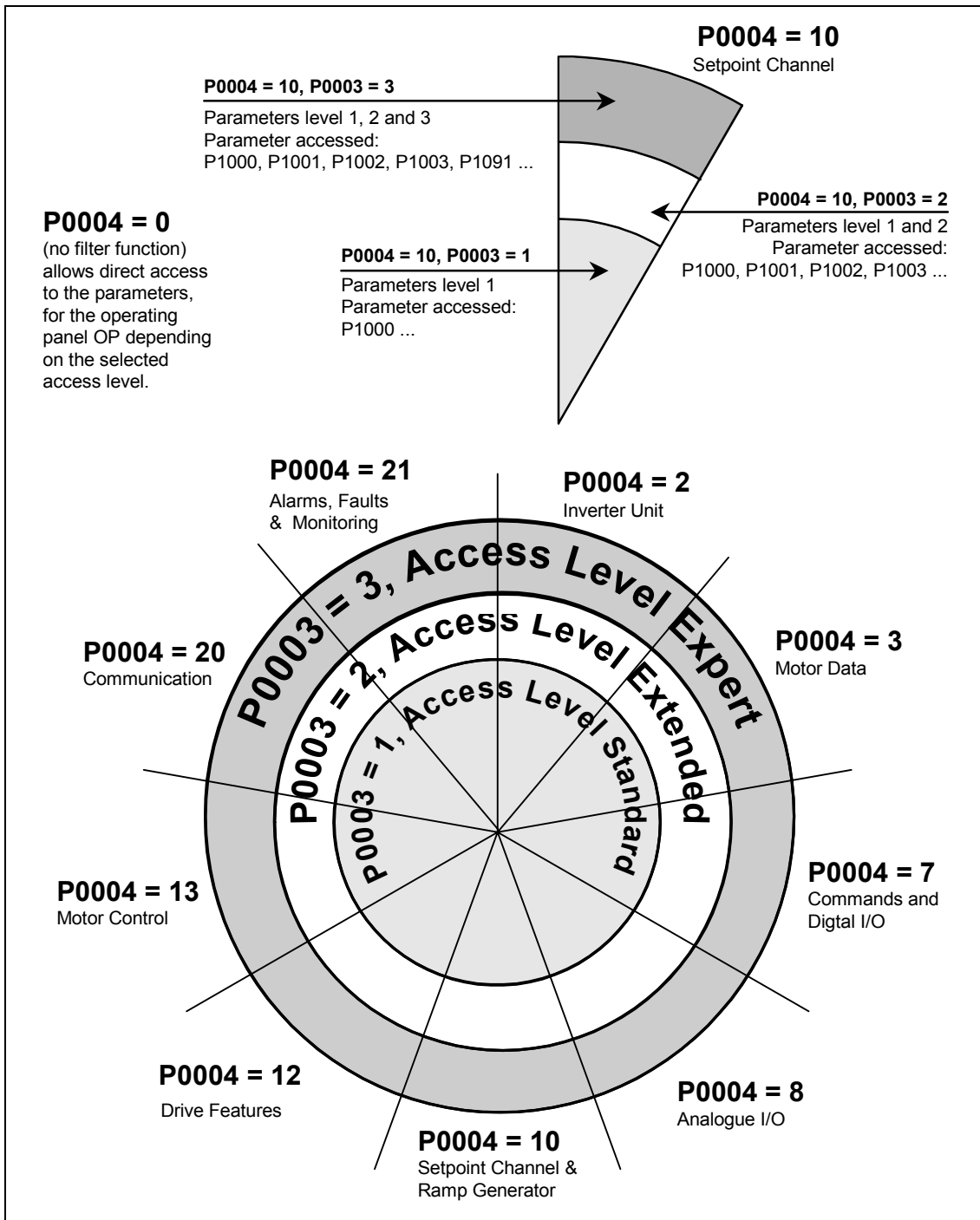

Figure 5-1 Parameter Overview

5.3 Parameter List (short form)

Explanatory information on following table:

- Default: Factory setting
- Level: Access level (Acc)
- DS Inverter status (Drive State), indicates the inverter state in which a parameter can be modified (see P0010).
 - ◆ C Commissioning
 - ◆ U Run
 - ◆ T Ready to run
- QC Quick Commissioning
 - ◆ Q Parameter can be modified in the Quick Commissioning state.
 - ◆ N Parameter cannot be modified in the Quick Commissioning state.

Always

ParNr	ParText	Default	Acc	DS	QC
r0000	Drive display	-	1	-	-
P0003	User access level	1	1	CUT	N
P0004	Parameter filter	0	3	CUT	N
P0010	Commissioning parameter filter	0	1	CT	N

Quick Commissioning

ParNr	ParText	Default	Acc	DS	QC
P0100	Europe / North America	0	1	C	Q
P0101	Hidden Switch Setting	0	1	C	Q
P3900	End of quick commissioning	0	1	C	Q

Parameter Reset

ParNr	ParText	Default	Acc	DS	QC
P0970	Factory reset	0	1	C	N

Inverter Unit (P0004 = 2)

ParNr	ParText	Default	Acc	DS	QC
r0018	Firmware version	-	3	-	-
r0026	CO: Act. DC-link voltage	-	2	-	-
r0206	Rated inverter power [kW] / [hp]	-	3	-	-
r0207	Rated inverter current	-	3	-	-
r0209	Maximum inverter current	-	3	-	-
P0210	Supply voltage	230	3	CT	N
P0290	Inverter overload reaction	2	3	CT	N
P1800	Pulse frequency	4	3	CUT	N

Motor Data (P0004 = 3)

ParNr	ParText	Default	Acc	DS	QC
r0034	CO: Motor temperature (i^2t)	-	3	-	-
P0300	Select motor type	1	3	C	Q
P0304	Rated motor voltage	230	1	C	Q
P0305	Rated motor current	3.25	1	C	Q
P0307	Rated motor power	0.75	1	C	Q
P0308	Rated motor cosPhi	0.000	3	C	Q
P0309	Rated motor efficiency	0.0	3	C	Q
P0310	Rated motor frequency	50.00	1	C	Q
P0311	Rated motor speed	0	1	C	Q
P0335	Motor cooling	0	3	CT	Q
P0340	Calculation of motor parameters	0	3	CT	N
P0610	Motor I^2t temperature reaction	2	3	CT	N
P0611	Motor I^2t time constant	100	3	CT	N
P0614	Motor I^2t overload warning level	100.0	3	CUT	N
P0640	Motor overload factor [%]	190.0	3	CUT	Q
P1910	Select motor data identification	0	2	CT	Q

Commands and Digital I/O (P0004 = 7)

ParNr	ParText	Default	Acc	DS	QC
r0002	Drive state	-	3	-	-
r0019	CO/BO: BOP control word	-	3	-	-
r0052	CO/BO: Act. Status word 1	-	2	-	-
r0053	CO/BO: Act. Status word 2	-	2	-	-
r0054	CO/BO: Act. Control word 1	-	3	-	-
r0055	CO/BO: Add. Act. Control word	-	3	-	-
P0700	Selection of command source	2	1	CT	Q
P0701	Function of digital input 1	1	2	CT	N
P0702	Function of digital input 2	12	2	CT	N
P0703	Function of digital input 3	9	2	CT	N
P0704	Function of digital input 4	0	2	CT	N
P0719[2]	Selection of cmd. & freq. Setp.	0	3	CT	N
r0722	CO/BO: Binary input values	-	3	-	-
P0724	Debounce time for digital inputs	3	3	CT	N
P0731	BI: Function of digital output 1	52:3	2	CUT	N
r0747	CO/BO: State of digital outputs	-	3	-	-
P0748	Invert digital outputs	0	3	CUT	N
P0810	BI: CDS bit 0 (Local / Remote)	0:0	3	CUT	N

Analogue I/O (P0004 = 8)

ParNr	ParText	Default	Acc	DS	QC
r0752	Act. input of ADC [V]	-	3	-	-
P0753	Smooth time ADC	3	3	CUT	N
r0754	Act. ADC value after scaling [%]	-	2	-	-
P0757	Value x1 of ADC scaling [V]	0	3	CUT	N
P0758	Value y1 of ADC scaling	0.0	3	CUT	N
P0759	Value x2 of ADC scaling [V]	24	3	CUT	N
P0760	Value y2 of ADC scaling	100.0	3	CUT	N
P0761	Width of ADC deadband [V]	0	3	CUT	N

Setpoint Channel and Ramp Generator (P0004 = 10)

ParNr	ParText	Default	Acc	DS	QC
P1000	Selection of frequency setpoint	2	1	CT	Q
P1001	Fixed frequency 1	0.00	2	CUT	N
P1002	Fixed frequency 2	5.00	2	CUT	N
P1003	Fixed frequency 3	10.00	2	CUT	N
r1024	CO: Act. Fixed frequency	-	3	-	-
P1031	Setpoint memory of the MOP	0	2	CUT	N
P1032	Inhibit reverse direction of MOP	1	3	CT	N
P1040	Setpoint of the MOP	5.00	3	CUT	N
P1070	CI: Main setpoint	755:0	3	CT	N
P1071	CI: Main setpoint scaling	1:0	3	CT	N
P1075	CI: Additional setpoint	0:0	3	CT	N
r1078	CO: Total frequency setpoint	-	3	-	-
P1080	Min. frequency	0.00	1	CUT	Q
P1082	Max. frequency	50.00	1	CT	Q
P1091	Skip frequency 1	0.00	3	CUT	N
P1120	Ramp-up time	10.00	1	CUT	Q
P1121	Ramp-down time	10.00	1	CUT	Q
P1130	Ramp-up initial rounding time	0.00	3	CUT	N
P1131	Ramp-up final rounding time	0.00	3	CUT	N
P1132	Ramp-down initial rounding time	0.00	3	CUT	N
P1133	Ramp-down final rounding time	0.00	3	CUT	N
P1134	Rounding type	0	3	CUT	N
P1135	OFF3 ramp-down time	5.00	3	CUT	Q
r1170	CO: Frequency setpoint after RFG	-	3	-	-

Drive Features (P0004 = 12)

ParNr	ParText	Default	Acc	DS	QC
P0005	Display selection	21	2	CUT	N
P1200	Flying start	0	3	CUT	N
P1202	Motor-current: Flying start	100	3	CUT	N
P1203	Search rate: Flying start	100	3	CUT	N
P1210	Automatic restart	1	2	CUT	N
P1215	Holding brake enable	0	3	T	N
P1216	Holding brake release delay	1.0	3	T	N
P1217	Holding time after ramp down	1.0	3	T	N
P1232	DC braking current	100	3	CUT	N
P1233	Duration of DC braking	0	3	CUT	N
P1236	Compound braking current	0	3	CUT	N
P1240	Configuration of Vdc controller	1	3	CT	N

Motor Control (P0004 = 13)

ParNr	ParText	Default	Acc	DS	QC
r0020	CO: Act. frequency setpoint	-	2	-	-
r0021	CO: Act. frequency	-	2	-	-
r0022	Act. rotor speed	-	3	-	-
r0024	CO: Act. output frequency	-	3	-	-
r0025	CO: Act. output voltage	-	3	-	-
r0056	CO/BO: Status of motor control	-	2	-	-
r0067	CO: Act. output current limit	-	3	-	-
P1300	Control mode	0	2	CT	Q
P1310	Continuous boost	50.0	2	CUT	N
P1311	Acceleration boost	0.0	3	CUT	N
P1312	Starting boost	0.0	2	CUT	N
P1316	Boost end frequency	20.0	3	CUT	N
P1320	Programmable V/f freq. coord. 1	0.00	3	CT	N
P1321	Programmable V/f volt. coord. 1	0.0	3	CUT	N
P1322	Programmable V/f freq. coord. 2	0.00	3	CT	N
P1323	Programmable V/f volt. coord. 2	0.0	3	CUT	N
P1324	Programmable V/f freq. coord. 3	0.00	3	CT	N
P1325	Programmable V/f volt. coord. 3	0.0	3	CUT	N
P1333	Start frequency for FCC	10.0	3	CUT	N
P1335	Slip compensation	0.0	3	CUT	N
P1340	Imax controller prop. gain	0.000	3	CUT	N

Communication (P0004 = 20)

ParNr	ParText	Default	Acc	DS	QC
P0927	Parameter changeable via	15	3	CUT	N
r0964[5]	Firmware version data	-	3	-	-
P0971	Transfer data from RAM to EEPROM	0	3	CUT	N
P2000	Reference frequency	50.00	3	CT	N
P2009[2]	USS normalization	0	3	CT	N
P2010[2]	USS baudrate	6	3	CUT	N
P2011[2]	USS address	0	3	CUT	N
P2012[2]	USS PZD length	2	3	CUT	N
P2013[2]	USS PKW length	127	3	CUT	N
P2014[2]	USS telegram off time	0	3	CT	N
r2015[4]	CO: PZD from BOP link (USS)	-	3	-	-
P2016[4]	CI: PZD to BOP link (USS)	52:0	3	CT	N
r2018[4]	CO: PZD from COM link (USS)	-	3	-	-
P2019[4]	CI: PZD to COM link (USS)	52:0	3	CT	N
r2024[2]	USS error-free telegrams	-	3	-	-
r2025[2]	USS rejected telegrams	-	3	-	-
r2026[2]	USS character frame error	-	3	-	-
r2027[2]	USS overrun error	-	3	-	-
r2028[2]	USS parity error	-	3	-	-
r2029[2]	USS start not identified	-	3	-	-
r2030[2]	USS BCC error	-	3	-	-
r2032	BO: CtrlWrd1 from BOP link (USS)	-	3	-	-
r2031[2]	USS length error	-	3	-	-
r2033	BO: CtrlWrd2 from BOP link (USS)	-	3	-	-
r2036	BO: CtrlWrd1 from COM link (USS)	-	3	-	-
r2037	BO: CtrlWrd2 from COM link (USS)	-	3	-	-

Alarms, Faults and Monitoring (P0004 = 21)

ParNr	ParText	Default	Acc	DS	QC
P0952	Total number of faults	0	3	CT	N
r0947[8]	Last fault code	-	2	-	-
r2110[4]	Warning number	-	3	-	-
r2114[2]	Run time counter	-	3	-	-
P2167	Switch-off frequency f_off	1.00	3	CUT	N

6 Troubleshooting



WARNING

- ◆ Repairs on equipment may only be carried out by **Siemens Service**, by repair centers **authorized by Siemens** or by qualified personnel who are thoroughly acquainted with all the warnings and operating procedures contained in this manual.
- ◆ Any defective parts or components must be replaced using genuine Siemens authorised parts.
- ◆ Risk of electric shock. The DC link capacitors remain charged for five minutes after power has been removed. **It is not permissible to open the equipment until 5 minutes after the power has been removed.**

6.1 Troubleshooting with the Standard Inverter LED

The following is a description of the fault and warning indications given by the LED on the Standard Inverter:

- Inverter Off/No supply: No LED lit.
- Power On/Ready: 1000 ms On / 1000 ms Off
- Inverter Running OK: Steady LED
- General Warning: 500 ms On / 200 ms Off
- Fault Condition: 100 ms On / 100 ms Off

6.2 Troubleshooting with the Operator Panel (OP)

If the display shows a fault or warning code, please refer to Section 6.3.

If the motor fails to start when the ON command has been given:

- Check that P0010 = 0.
- Check that a valid ON signal is present.
- Check that P0700 = 2 (for digital input control) or P0700 = 1 (for OP control).
- Check that the setpoint is present (0 to 10V on Terminal 7) or the setpoint has been entered into the correct parameter, depending upon the setpoint source (P1000). See the Parameter List for further details.

If the motor fails to run after changing the parameters, set P0010 = 30 then P0970 = 1 and press **P** to reset the inverter to the factory default parameter values.

Now use a switch between cobtrol terminals **1** and **4**. The drive should now run to the defined setpoint by analogue input.

NOTICE

Motor data must relate to the inverter data power range and voltage.

6.3 Fault messages

Fault	Possible Causes	Diagnose & Remedy	Reaction
F0001 OverCurrent	<ul style="list-style-type: none"> ➤ Motor power (P0307) does not correspond to the inverter power (r0206) ➤ Motor lead short circuit ➤ Earth faults 	Check the following: <ol style="list-style-type: none"> 1. Motor power (P0307) must correspond to inverter power (r0206). 2. Cable length limits must not be exceeded. 3. Motor cable and motor must have no short-circuits or earth faults 4. Motor parameters must match the motor in use 5. Motor must not be obstructed or overloaded. <ul style="list-style-type: none"> ➤ Increase the ramp time ➤ Reduce the boost level 	OFF2
F0002 OverVoltage	<ul style="list-style-type: none"> ➤ Overvoltage can be caused either by too high main supply voltage or if motor is in regenerative mode. ➤ Regenerative mode can be caused by fast ramp downs or if the motor is driven from an active load. 	Check the following: <ol style="list-style-type: none"> 1. Supply voltage (P0210) must lie within limits indicated on the inverter rating plate. 2. DC-link voltage controller must be enabled (P1240) and parameterized properly. 3. Ramp-down time (P1121) must match inertia of load. NOTE Higher inertia requires longer ramp times	OFF2
F0003 UnderVoltage	<ul style="list-style-type: none"> ➤ Main supply failed. ➤ Shock load outside specified limits. 	Check the following: <ol style="list-style-type: none"> 1. Supply voltage (P0210) must lie within limits indicated on the inverter rating plate. 2. Supply must not be susceptible to temporary failures or voltage reductions. 	OFF2
F0004 Inverter Over Temperature	<ul style="list-style-type: none"> ➤ Ventilation inadequate ➤ Ambient temperature is too high. 	Check the following: <ol style="list-style-type: none"> 1. Pulse frequency must be set to default value 2. Ambient temperature could be higher than specified for the inverter 	OFF2
F0005 Inverter I²t	<ul style="list-style-type: none"> ➤ Inverter overloaded. ➤ Duty cycle too demanding. ➤ Motor power (P0307) exceeds inverter power capability (r0206). 	Check the following: <ol style="list-style-type: none"> 1. Load duty cycle must lie within specified limits. 2. Motor power (P0307) must match inverter power (r0206) 	OFF2
F0011 Motor Over Temperature I²t	Motor overloaded	Check the following: <ol style="list-style-type: none"> 1. Load duty cycle must be correct 2. Motor temperature warning level (P0604) must match. 	OFF1
F0041	Stator resistance measurement failure	<ul style="list-style-type: none"> ➤ Check if the motor is connected to the inverter. ➤ Check that the motor data have been entered correctly. 	OFF2
F0051 Parameter EEPROM Fault	Read or write failure while saving non-volatile parameter.	Factory Reset and new parameterization Change drive	OFF2
F0052 power stack Fault	Read failure for power stack information or invalid data.	Change drive	OFF2

Fault	Possible Causes	Diagnose & Remedy	Reaction
F0060 Asic Timeout	Internal communications failure	If fault persists, change inverter Contact Service Department	OFF2
F0071 USS (BOP- link) setpoint fault	No setpoint values from USS during telegram off time	Check USS master	OFF2
F0072 USS (COMM link) setpoint fault	No setpoint values from USS during telegram off time	Check USS master	OFF2
F0085 External Fault	External fault triggered via terminal inputs	Disable terminal input for fault trigger.	OFF2
F0101 Stack Overflow	Software error or processor failure	<ul style="list-style-type: none"> ➤ Cycle through power (on/off). ➤ Replace drive if fault is not corrected. 	OFF2
F0450 BIST Tests Failure (Service Mode Only)	Selftest failed	<ul style="list-style-type: none"> ➤ Drive may run but some features will not work properly. ➤ Replace drive. 	OFF2

6.4 Alarms

Alarm	Possible Causes	Diagnose & Remedy	Reaction
A0501 Current Limit	<ul style="list-style-type: none"> ➤ Motor power does not correspond to the inverter power ➤ Motor leads are too long ➤ Earth faults 	Check the following: <ol style="list-style-type: none"> 1. Motor power (P0307) must correspond to inverter power (r0206). 2. Cable length limits must not be exceeded. 3. Motor cable and motor must have no short-circuits or earth faults 4. Motor parameters must match the motor in use 5. Motor must not be obstructed or overloaded <ul style="list-style-type: none"> ➤ Increase the ramp-up-time. ➤ Reduce the boost. 	--
A0502 Overvoltage limit	<ul style="list-style-type: none"> ➤ Overvoltage limit is reached. ➤ This warning can occur during ramp down, if the dc-link controller is disabled (P1240 = 0). 	If this warning is displayed permanently, check drive input voltage .	--
A0503 UnderVoltage Limit	Main supply failed	Check main supply voltage (P0210).	--
A0504 Inverter Over Temperature	Warning level of inverter heat-sink temperature (P0614) is exceeded, resulting in pulse frequency reduction and/or output frequency reduction (depending on parametrization in (P0610)	Check the following: <ol style="list-style-type: none"> 1. Ambient temperature must lie within specified limits 2. Load conditions and duty cycle must be appropriate 	--
A0505 Inverter I²t	Warning level exceeded, current will be reduced if parameterized (P0610 = 1)	Check that duty cycle lies within specified limits	--
A0506 Inverter duty cycle	Difference between heatsink and IGBT junction temperature exceeds warning limits	Check that duty cycle and shock loads lie within specified limits	--
A0511 Motor Over Temperature I²t	<ul style="list-style-type: none"> ➤ Motor overloaded. ➤ Load duty cycle too high. 	Check the following: <ol style="list-style-type: none"> 1. P0611 (motor I²t time constant) should be set to appropriate value 2. P0614 (Motor I²t overload warning level) should be set to suitable level 	--
A0600 RTOS Overrun Warning	Software problem	Contact Service Department	--
A0910 Vdc-max controller de-activated	<ul style="list-style-type: none"> ➤ Vdc max controller has been de-activated ➤ Occurs if main supply voltage is permanently too high. ➤ Occurs if motor is driven by an active load, causing motor to go into regenerative mode. ➤ Occurs at very high load inertias, when ramping down. 	Check the following: <ol style="list-style-type: none"> 1. Input voltage must lie within range. 2. Load must be matched. 3. In certain cases apply braking resistor. 	--
A0911 Vdc-max controller active	Vdc max controller is active; so ramp-down times will be increased automatically to keep DC-link voltage (r0026) within limits	Check the inverter input voltage (P0210)	--

Alarm	Possible Causes	Diagnose & Remedy	Reaction
A0920 ADC parameters not set properly.	ADC parameters should not be set to identical values, since this would produce illogical results.	Check P0757, P0758, P0759 and P0760	--
A0922 No load applied to inverter	No Load is applied to the inverter. As a result, some functions may not work as under normal load conditions.	Check that a load has been applied to the inverter.	--

7 MICROMASTER 410 Specifications

Table 7-1 MICROMASTER 410 Performance Ratings

Feature	Specification
Mains Operating Voltage & Power Ranges	100 to 120 V \pm 10% 1AC 0.12 kW – 0.55 kW 200 to 240 V \pm 10% 1AC 0.12 kW – 0.75 kW
Input Frequency	47 to 63 Hz
Output frequency	0 Hz - 650 Hz
Power Factor	\geq 0.95
Inverter Efficiency	96 to 97 %
Overload Capability	Up to 150 % of rated output current for 60 seconds followed by 85 % of rated output current for 240 seconds (cycle time 300 seconds)
Inrush Current	Less than rated input current
Control Method	Linear V/f ; Parabolic V/f; Flux Current Control (FCC); Multi-point V/f
Pulse Frequency	2 kHz to 16 kHz (2 kHz steps) 8 kHz Standard
Fixed Frequencies	3; programmable
Skip Frequencies	1; programmable
Setpoint Resolution	0.01Hz digital, 0.01 Hz serial, 10 bit analogue (motor potentiometer 0.1 Hz)
Output Frequency Resolution	0.01 Hz digital, 0.01 Hz serial
Digital Inputs (PNP type)	3; freely programmable, non isolated, SIMATIC compatible
Analog Input	1; for setpoint (0 to 10 V, scalable or for use as 4 th digital input)
Relay Output	1; parameterizable, 30 V DC / 5 A (resistive), 250 V AC / 2 A (inductive)
Serial Interface	RS-485, for operation with USS protocol
Electromagnetic Compatibility	Variant with integrated EMC filter according to EN 61800-3
Braking	DC braking and Compound braking
Protection Level	IP20
Operation Temperature	-10 °C to +50 °C
Storage Temperature	-40 °C to +70 °C
Humidity	95 % RH – non-condensing
Operational Altitudes	Up to 1000 m above sea level without derating
Protection Features	Undervoltage, Overvoltage, Overload, Ground Faults, Short circuit, Stall Prevention, Motor Overtemperature, Inverter Overtemperature Protection
Standards	UL, cUL, CE, C-tick
CE Marked	Conformity with EC Low Voltage Directive 73/23/EEC filtered variants are also conform to Electromagnetic Compatibility Directive 89/336/EEC
Design/Manufacture	In accordance with ISO 9001

Table 7-2 Terminal Torques – Field Wiring Connectors

		Motorside PE terminal	All other terminals
Tightening Torque	[Nm]	0.8	1.1
	[lbf.in]	7.1	9.8

Table 7-3 MICROMASTER 410 Specifications

Input voltage range 1 AC 200 V – 240 V, ± 10 % (with built in Class B Filter)

Order No.	6SE6410-	2BB11 -2AA0	2BB12 -5AA0	2BB13 -7AA0	2BB15 -5BA0	2BB17 -5BA0
Motor Output Rating	[kW]	0.12	0.25	0.37	0.55	0.75
	[hp]	0.16	0.33	0.5	0.75	1.0
Output Current Max.	[A]	0.9	1.7	2.3	3.2	4.2
Input Current	[A]	1.5	3.0	4.4	5.8	7.8
Recommended Fuse	[A]	10	10	10	10	16
		3NA3803	3NA3803	3NA3803	3NA3803	3NA3805
Input Cable Min.	[mm ²]	1.0	1.0	1.0	1.0	1.5
	[awg]	16	16	16	16	14
Input Cable Max.	[mm ²]	2.5	2.5	2.5	2.5	2.5
	[awg]	12	12	12	12	12
Output Cable Min.	[mm ²]	1.0	1.0	1.0	1.0	1.0
	[awg]	16	16	16	16	16
Output Cable Max.	[mm ²]	2.5	2.5	2.5	2.5	2.5
	[awg]	12	12	12	12	12
Weight	[kg]	0.8	0.8	0.8	1.0	1.0
	[lbs]	1.8	1.8	1.8	2.2	2.2
Dimensions	w [mm]	69.0	69.0	69.0	69.0	69.0
	h [mm]	150.0	150.0	150.0	150.0	150.0
	d [mm]	118.0	118.0	118.0	138.0	138.0
	w [inches]	2.72	2.72	2.72	2.72	2.72
	h [inches]	5.90	5.90	5.90	5.90	5.90
	d [inches]	4.65	4.65	4.65	5.43	5.43

Input voltage range 1 AC 200 V – 240 V, ± 10 % (Unfiltered)

Order No.	6SE6410-	2UB11 -2AA0	2UB12 -5AA0	2UB13 -7AA0	2UB15 -5BA0	2UB17 -5BA0
Motor Output Rating	[kW]	0.12	0.25	0.37	0.55	0.75
	[hp]	0.16	0.33	0.5	0.75	1.0
Output Current Max.	[A]	0.9	1.7	2.3	3.2	4.2
Input Current	[A]	1.5	3.0	4.4	5.8	7.8
Recommended Fuse	[A]	10	10	10	10	16
		3NA3803	3NA3803	3NA3803	3NA3803	3NA3805
Input Cable Min.	[mm ²]	1.0	1.0	1.0	1.0	1.5
	[awg]	16	16	16	16	14
Input Cable Max.	[mm ²]	2.5	2.5	2.5	2.5	2.5
	[awg]	12	12	12	12	12
Output Cable Min.	[mm ²]	1.0	1.0	1.0	1.0	1.0
	[awg]	16	16	16	16	16
Output Cable Max.	[mm ²]	2.5	2.5	2.5	2.5	2.5
	[awg]	12	12	12	12	12
Weight	[kg]	0.8	0.8	0.8	1.0	1.0
	[lbs]	1.8	1.8	1.8	2.2	2.2
Dimensions	w [mm]	69.0	69.0	69.0	69.0	69.0
	h [mm]	150.0	150.0	150.0	150.0	150.0
	d [mm]	118.0	118.0	118.0	138.0	138.0
	w [inches]	2.72	2.72	2.72	2.72	2.72
	h [inches]	5.90	5.90	5.90	5.90	5.90
	d [inches]	4.65	4.65	4.65	5.43	5.43

Input voltage range 1 AC 100 V – 120 V, ± 10 % (Unfiltered)

Order No.	6SE6410-	2UA11 -2AA0	2UA12 -5AA0	2UA13 -7AA0	2UA15 -5BA0
Motor Output Rating	[kW]	0.12	0.25	0.37	0.55
	[hp]	0.16	0.33	0.5	0.75
Output Current Max.	[A]	0.9	1.7	2.3	3.2
Input Current	[A]	4.6	7.5	10.1	13.4
Recommended Fuse	[A]	10	10	16	20
		3NA3803	3NA3803	3NA3805	3NA3807
Input Cable Min.	[mm ²]	1.0	1.0	1.5	2.5
	[awg]	16	16	14	12
Input Cable Max.	[mm ²]	2.5	2.5	2.5	2.5
	[awg]	12	12	12	12
Output Cable Min.	[mm ²]	1.0	1.0	1.0	1.0
	[awg]	16	16	16	16
Output Cable Max.	[mm ²]	2.5	2.5	2.5	2.5
	[awg]	12	12	12	12
Weight	[kg]	0.8	0.8	0.8	1.0
	[lbs]	1.8	1.8	1.8	2.2
Dimensions	w [mm]	69.0	69.0	69.0	69.0
	h [mm]	150.0	150.0	150.0	150.0
	d [mm]	118.0	118.0	118.0	138.0
	w [inches]	2.72	2.72	2.72	2.72
	h [inches]	5.90	5.90	5.90	5.90
	d [inches]	4.65	4.65	4.65	5.43

8 Options

The following accessories are available as options for your MICROMASTER MM410 Inverter. For more details please refer to the catalogue or contact your local Siemens sales office if you require assistance.

8.1 Variant Independent Options

- Operator Panel (OP)
- DIN Rail Mounting Kit
- PC to inverter connection kit
- Software commissioning tools:
 - ◆ “DriveMonitor”
 - ◆ “Starter”

8.2 Variant Dependent Options

- Low leakage Class B filter
- Line commutating choke

9 Electro-Magnetic Compatibility (EMC)

9.1 Electro-Magnetic Compatibility (EMC)

All manufacturers / assemblers of electrical apparatus which “performs a complete intrinsic function and is placed on the market as a single unit intended for the end user” must comply with the EMC directive EEC/89/336.

There are two routes for the manufacturer/assembler to demonstrate compliance:

9.1.1 Self-Certification

This is a manufacturer's declaration that the European standards applicable to the electrical environment for which the apparatus is intended have been met. Only standards that have been officially published in the Official Journal of the European Community can be cited in the manufacturer's declaration.

9.1.2 Technical Construction File

A technical construction file can be prepared for the apparatus describing its EMC characteristics. This file must be approved by a ‘Competent Body’ appointed by the appropriate European government organization. This approach allows the use of standards that are still in preparation.

NOTE

However, MICROMASTER 410 is designed to be used only by professional endusers with EMC knowledge. It is not designed for users having no EMC knowledge.

In any case this operating instructions cover sufficient information which enables the professional enduser to implement from his side all measures to ensure electromagnetical compatibility.

9.1.3 EMC Directive Compliance with Harmonics Regulations

From 1st January 2001 all electrical apparatus covered by the EMC Directive will have to comply with EN 61000-3-2 "Limits for harmonic current emissions (equipment input ≤ 16 A per phase)".

All Siemens variable speed drives of the MICROMASTER, MIDIMASTER, MICROMASTER Eco and COMBIMASTER ranges, which are classified as "Professional Equipment" within the terms of the standard, fulfill the requirements of the standard.

Special considerations for 250 W to 550 W drives with 230 V 1ac mains supplies when used in non-industrial applications

For units in this voltage and power range the following warning applies:

"This equipment requires supply authority acceptance for connection to the public supply network". Please refer to EN 61000-3-12 sections 5.3 and 6.4 for further information. Units connected to Industrial Networks¹ do not require connection approval (see EN 61800-3, section 6.1.2.2).

The harmonic current emissions from these products are described in the table below:

Rating	Typical Harmonic Current (A)					Typical Harmonic Current (%)					Typical Voltage Distortion		
											Distribution Transformer Rating		
											10kVA	100kVA	1MVA
	3 rd	5 th	7 th	9 th	11 th	3 rd	5 th	7 th	9 th	11 th	THD (%)	THD (%)	THD (%)
250W 230V 1ac	2.40	1.70	0.95	0.40	0.20	83	59	33	14	7	0.67	0.067	0.0067
370W 230V 1ac	3.50	2.50	1.40	0.60	0.25	85	61	34	15	6	0.97	0.097	0.0097
550W 230V 1ac	4.60	3.30	1.80	0.70	0.40	87	62	34	13	8	1.27	0.127	0.0127

The allowed harmonic currents for "professional equipment" with an input power > 1 kW are not yet defined. Therefore, any electrical apparatus containing the above drives which has an input power > 1 kW will not require connection approval.

Alternatively, the necessity to apply for connection approval can be avoided by fitting the input chokes recommended in the technical catalogues (except 550 W 230 V 1ac units).

¹ Industrial Networks are defined as those which do not supply buildings used for domestic purposes.

9.1.4 General cases of EMC performance

Three General cases of EMC performance are available as detailed below:

Case 1: General Industrial

Compliance with the EMC Product Standard for Power Drive Systems EN 61800-3 for use in **Second Environment (Industrial)** and **Restricted Distribution**.

Table 9-1 Case 1 - General Industrial

EMC Phenomenon	Standard	Level
Emissions:		
Radiated Emissions	EN 55011	Level group 1, class A
Conducted Emissions	EN 61800-3	Limits are weaker as EN55011, class A, group 1
Immunity:		
Electrostatic Discharge	EN 61000-4-2	8 kV air discharge
Burst Interference	EN 61000-4-4	2 kV power cables (Level 3), 1 kV control (Level 3)
Radio Frequency Electromagnetic Field	EN61000-4-3	26-1000 MHz, 10 V/m

Case 2: Filtered Industrial

This level of performance will allow the manufacturer/assembler to self-certify their apparatus for compliance with the EMC directive for the industrial environment as regards the EMC performance characteristics of the power drive system. Performance limits are as specified in the Generic Industrial Emissions and Immunity standards EN 50081-2 and EN 61000-6-2.

Table 9-2 Case 2 - Filtered Industrial

EMC Phenomenon	Standard	Level
Emissions:		
Radiated Emissions	EN 55011	Level group 1, class A
Conducted Emissions	EN 61800-3	Level are weaker as EN55011 class A, group 1
Immunity:		
Supply Voltage Distortion	EN 61000-2-4	
Voltage Fluctuations, Dips, Unbalance, Frequency Variations	EN 61000-2-1	
Electrostatic Discharge	EN 61000-4-2	8 kV air discharge
Burst Interference	EN 61000-4-4	2 kV power cables (Level 3), 2 kV control (Level 4)
Radio Frequency Electromagnetic Field, amplitude modulated	EN 61000-4-3	80-1000 MHz, 10 V/m, 80% AM, power and signal lines

Case 3: Filtered - for residential, commercial and light industry

This level of performance will allow the manufacturer / assembler to self-certify compliance of their apparatus with the EMC directive for the residential, commercial and light industrial environment as regards the EMC performance characteristics of the power drive system. Performance limits are as specified in the generic emission and immunity standards EN 50081-1 and EN 50082-1.

Table 9-3 Case 3 - Filtered for Residential, Commercial and Light Industry

EMC Phenomenon	Standard	Level
Emissions:		
Radiated Emissions*	EN 55022	Level for equipment class B
Conducted Emissions	EN 61800-3	category C1: level according EN 55011, class B category C2: level according EN55011, class A
Immunity:		
Supply Voltage Distortion	EN 61000-2-4	
Voltage Fluctuations, Dips, Unbalance, Frequency Variations	EN 61000-2-1	
Electrostatic Discharge	EN 61000-4-2	8 kV air discharge
Burst Interference	EN 61000-4-4	2 kV power cables (Level 3), 2 kV control (Level 4)

* These limits are dependent on the inverter being correctly installed inside a metallic switchgear enclosure. The limits will not be met if the inverter is not enclosed.

NOTICE

To achieve these performance levels, you must not exceed the default Pulse frequency nor use cables longer than 5 m (16.40 ft).

Table 9-4 Compliance Table

Model	Remarks
Case 1 – General Industrial	
6SE6410-2U***-**A0	Unfiltered units, all voltages and powers. The product standard EN 61800-3 + A11 for "Adjustable speed electrical power drive systems – Part3: EMC product standard including specific test methods" specifies limits for conducted emissions, which cannot be matched from unfiltered inverters in the 2 nd environment. If compliance with the product standard is required, filtered inverters (as described under case 2) have to be installed.
Case 2 – Filtered Industrial	
6SE6410-2B***-**A0	All units with integral filters for screened motor cables up to 10 m (32,80 ft) [Class A]

Case 3 – Filtered for residential, commercial and light industry	
6SE6410-2B***-**A0	<p>category C1²: All units with integral filters for screened motor cables up to 5 m (16.40 ft) [Class B]</p> <p>category C2³: All units with integral filters for screened motor cables up to 10 m (32.80 ft) [Class A]</p> <p>In addition a warning label will be required: “This is a product of category C2 according to IEC 61800-3. In a domestic environment this product may cause radio interference in which case mitigation measures may be required.”</p>
* denotes any value is allowed.	

² category C1: Power Drive system (PDS) of rated voltage less than 1000V, intended for use in the first environment.

³ category C2: Power Drive System (PDS) of rated voltage less than 1000V, which when used in the first environment is intended to be installed and commissioned only by a professional.

Appendices

A Fitting the Operator Panel

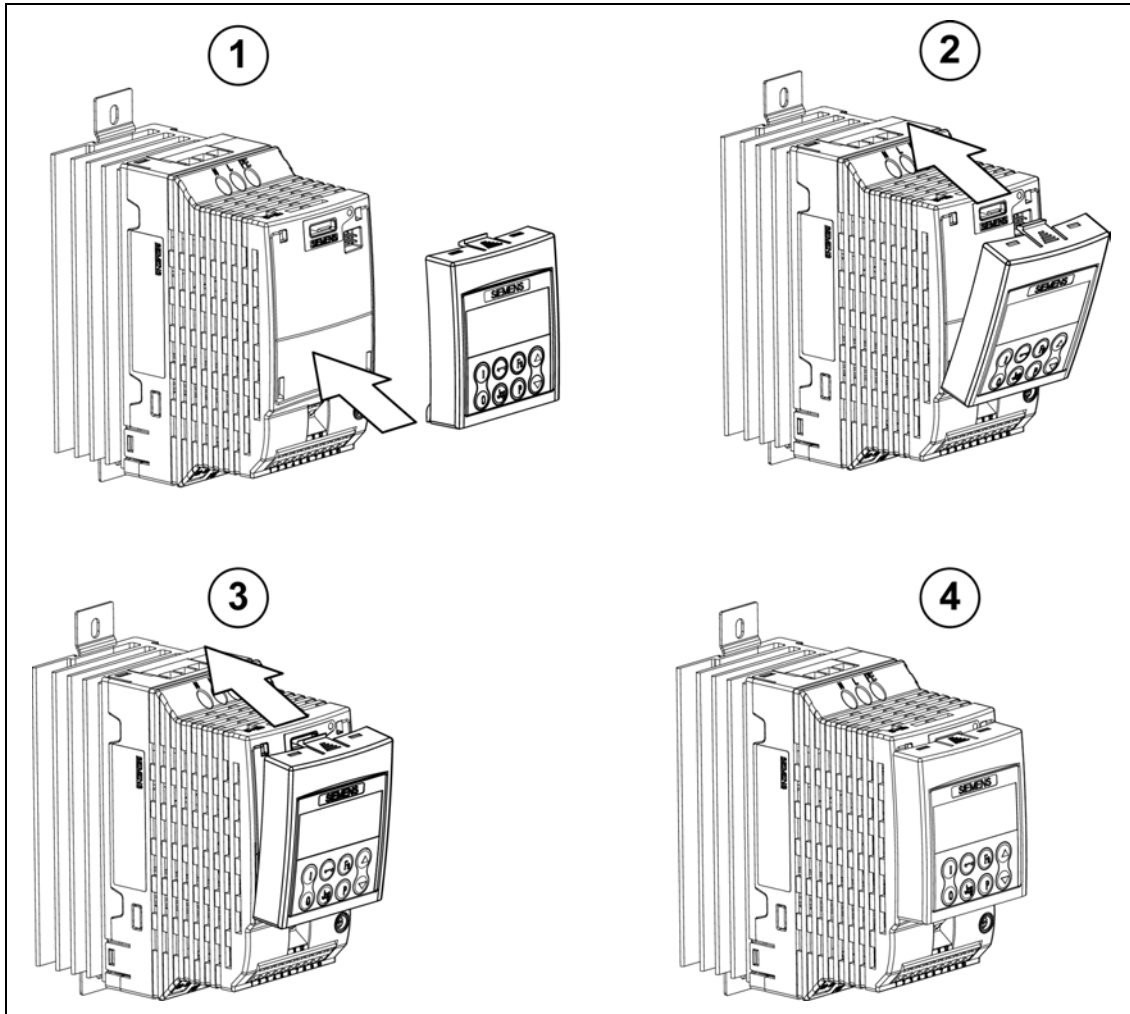

B Applicable Standards



European Low Voltage Directive

The MICROMASTER product range complies with the requirements of the Low Voltage Directive 73/23/EEC as amended by Directive 98/68/EEC. The units are certified for compliance with the following standards:

EN 50178 Electronic equipment for use in power installations
EN 60204-1 Safety of machinery - Electrical equipment of machines

European EMC Directive

When installed according to the recommendations described in this manual, the MICROMASTER fulfils all requirements of the EMC Directive as defined by the EMC Product Standard for Power Drive Systems EN61800-3.



Underwriters Laboratories

UL and CUL LISTED POWER CONVERSION EQUIPMENT.

ISO 9001

Siemens plc operates a quality management system, which complies with the requirements of ISO 9001.

Notice:

Machinery Directive

The devices are suitable for installation in machines. According to the machinery directive 89/392/EC the compliance requires a separate certificate of conformity. This certificate must be issued by the firm which constructs the plant or puts the machinery on the market.

C List of Abbreviations

AC	Alternating Current
AIN	Analog Input
CT	Constant Torque
DC	Direct Current
DIN	Digital Input
EEC	European Economic Community
ELCB	Earth Leakage Circuit Breaker
EMC	Electro-Magnetic Compatibility
EMI	Electro-Magnetic Interference
FAQ	Frequently Asked Question
FCC	Flux Current Control
FCL	Fast Current Limitation
IGBT	Insulated Gate Bipolar Transistor
I/O	Input and Output
LCD	Liquid Crystal Display
LED	Light Emitting Diode
OP	Operator Panel
PLC	Programmable Logic Controller
PTC	Positive Temperature Coefficient
RCCB	Residual Current Circuit Breaker
RCD	Residual Current Device
RPM	Revolutions Per Minute

Index

A

Access Levels.....	49
Altitude.....	19
Ambient operating conditions.....	19
Applicable standards	
European EMC Directive.....	76
European Low Voltage Directive.....	76
ISO 9001.....	76
Underwriters Laboratories.....	76
Atmospheric pollution.....	20

B

Basic operation.....	34
changing parameters with OP.....	38
external motor thermal overload protection.....	41, 43
general.....	42
with OP.....	42

C

Changing the Line Supply Frequency.....	35
Commissioning.....	31
Compound Braking.....	47
Contact address.....	5
Control Modes.....	48

D

DC braking.....	47
Default settings.....	34, 36
Dimensions and Torques.....	23
DIN Rail Mounting.....	25
Drill pattern for MICROMASTER 410.....	22

E

Electrical Installation.....	26
Electro-Magnetic Compatibility	
general.....	69
self-certification.....	69
technical construction file.....	69
Electro-Magnetic Interference.....	29
avoiding EMI.....	29
Electromagnetic radiation.....	20
EMC.....	69

EMC Directive Compliance.....	70
-------------------------------	----

EMC performance	
filtered for residential, commercial and light industry.....	72
filtered industrial class.....	71
general industrial class.....	71

EMI.....	29
----------	----

External motor thermal overload protection.....	43
-------------------------------------------------	----

F

Fault codes	
with the Operator Panel fitted.....	57
with the Standard Inverter LED.....	57

Faults and warnings	
OP fitted.....	48
Standard Inverter.....	48

Features.....	15
---------------	----

Fitting the Operator Panel.....	75
---------------------------------	----

Flux Current Control.....	48
---------------------------	----

Foreword.....	5
---------------	---

Frequency Setpoint.....	45
-------------------------	----

Front Panels.....	33
-------------------	----

H

Harmonic Currents	
tables.....	21

Humidity Range.....	19
---------------------	----

I

Installation.....	17
-------------------	----

after a period of storage.....	18
--------------------------------	----

Installation and cooling.....	20
-------------------------------	----

Internet Home Address.....	5
----------------------------	---

Inverter block diagram.....	32
-----------------------------	----

L

Linear V/f control.....	48
-------------------------	----

Long cables	
operation with.....	27

M

Main characteristics.....	15
---------------------------	----

Mechanical Installation.....	22
------------------------------	----

MICROMASTER 410	
available options	67
general	15
main characteristics	15
performance characteristics	16
protection characteristics	16
specifications	63
Motor connections	27
Motor data	41
Multi-point V/f control	48
O	
Operation	
starting and stopping the motor	46
Operation with	
long cables	27
Residual Current Device	27
ungrounded IT supplies	26
Operator Panel	36
changing the operator panel	75
default settings	36
warnings and faults states	34
Operator panels	
Overview	15
P	
Parameters	
changing parameters with OP	38
system parameters	49
Performance characteristics	16
Performance Ratings	63
Power and motor connections	27
single phase	29
Power connections	27
Power Losses	
output graphs	19
Protection characteristics	16
Q	
Quadratic V/f control	48
Qualified personnel	6
Quick commissioning	39
R	
Reset to Factory default	41
Residual Current Device	
operation with	27
S	
Safety instructions	7
Shock	20
Specifications	64
Status Display	34
T	
Technical Support	5
Temperature	19
Terminal Torques	64
Troubleshooting	57
U	
Ungrounded (IT) supplies	
operation with	26
V	
Variant Dependent Options	67
Variant Independent Options	67
Vibration	20
W	
Warnings, cautions & notes	
commissioning	8
definitions	6
dismantling & disposal	9
general	7
operation	9
repair	9
transport & storage	8
Water hazard	20
Wiring Guidelines EMI	30

Suggestions and/or Corrections

<p>To: Siemens AG Automation & Drives Group SD VM 4 P.O. Box 3269 D-91050 Erlangen Federal Republic of Germany</p> <p>Email: Technical.documentation@con.siemens.co.uk</p>	<p>Suggestions</p> <hr/> <p>Corrections</p> <p>For Publication/Manual: MICROMASTER 410</p> <p>User Documentation</p>
<p>From</p> <p>Name:</p> <p>Company/Service Department</p> <p>Address: _____</p> <p>_____</p> <p>Telephone: _____ / _____</p> <p>Telefax: _____ / _____</p>	<p>Operating Instructions</p> <p>Order Number: 6SE6400-5EA00-0BP0</p> <p>Date of Issue: 07/05</p> <hr/> <p>Should you come across any printing errors when reading this publication, please notify us on this sheet.</p> <p>Suggestions for improvement are also welcome.</p>

View of Unit

Standard Inverter

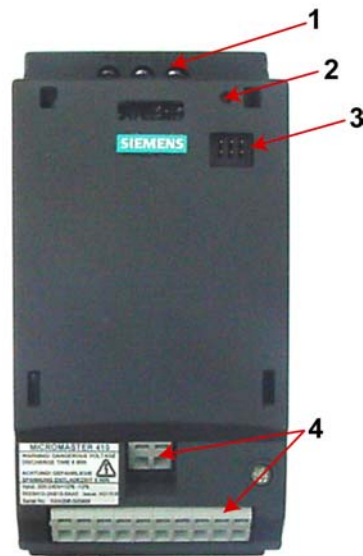

Key:

- 1. Line Terminals
- 2. Status LED
- 3. Operator Panel Connector
- 4. Control Terminals
- 5. Motor Terminals
- 6. DC+/DC- Terminals

Inverter with Optional Operator Panel Fitted



Connections & Terminals



Siemens AG
Bereich Automation and Drives (A&D)
Geschäftsgebiet Standard Drives (SD)
Postfach 3269, D-91050 Erlangen
Federal Republic of Germany

© Siemens AG, 2001, 2005
Subject to change without prior notice

Siemens Aktiengesellschaft

Order No.: 6SE6400-5EA00-0BP0
Date: **07/05**

