

Three phase input switch mode Power Supply S8PE

DIN-rail mounting, 3-phase input Switch mode Power Supply with a range of 5A to 40A output current

- 3 phase 400/480 or 200/230 VAC input
- 5, 10, 20 and 40A; 24 VDC output
- Higher stability, lower ripple and noise level
- Compact and attractive design, easily mounted to DIN rail (for 5, 10 and 20A types)
- Natural ventilation, no fan for less maintenance
- UL60950 (CSA22.2-60950), UL508 listing (CSA22.2-14) in addition to the CE mark
- Conform to EN61000-3-2
- All types can be used for parallel & serial operation

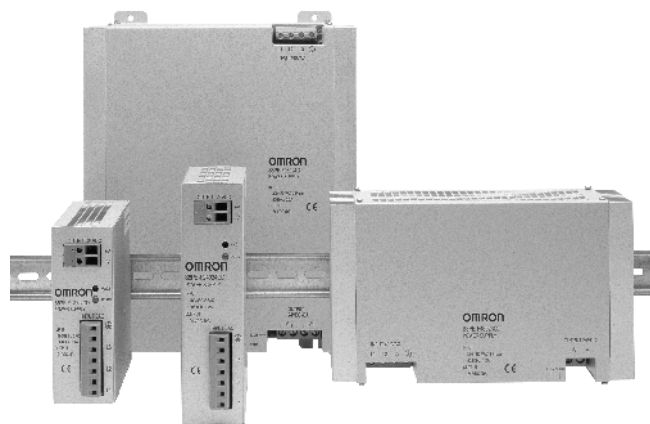

Ordering Information

■ S8PE

Input voltage	Power rating	Output voltage	Output current	With Front mounting Bracket	With DIN rail mounting Bracket
400/480 VAC 3-phase	120 W	24 V	5 A	—	S8PE-F12024CD
	240 W	24 V	10 A	—	S8PE-F24024CD
	480 W	24 V	20 A	S8PE-F48024C	S8PE-F48024CD
	960 W	24 V	40 A	S8PE-F96024C	—
200/230 VAC 3-phase	120 W	24 V	5 A	—	S8PE-J12024CD
	240 W	24 V	10 A	—	S8PE-J24024CD
	480 W	24 V	20 A	—	S8PE-J48024CD
	960 W	24 V	40 A	S8PE-J96024C	—

■ Model Number Legend

S8PE -

1 2 3 4

1. Input Voltage

F: 400-480 VAC 3-phase
J: 200-230 VAC 3-phase

2. Power Rating

120: 120 W
240: 240 W
480: 480 W
960: 960 W

3. Output Voltage

24: 24 V

4. Configuration

C: Covered type with Front-mounting bracket
CD: Covered type with DIN-rail track-mounting bracket

Specifications

Item	Nominal Input Voltage	F: 400...480 VAC				J: 200...230 VAC			
	Nominal Output Current	5 A	10 A	20 A	40 A	5 A	10 A	20 A	40 A
Efficiency (typical)	(Vin = 400 VAC, Pmax)	85%	88%	87%	90%	–	–	–	–
	(Vin = 480 VAC, Pmax)	84%	88%	87%	90%	–	–	–	–
	(Vin = 230 VAC, Pmax)	–	–	–	–	86%	88%	89%	91%
Input	Voltage range	340...766 VAC				180...264 VAC			
	Frequency	50/60 Hz							
	Current (max.) (Vin = Range min., Pmax)	0.5 A	1.0 A	1.5 A	2.5 A	1.0 A	2.0 A	3.0 A	5.0 A
	Power factor (typical) (Vin = 400 VAC, Pmax) (Vin = 480 VAC, Pmax) (Vin = 230 VAC, Pmax)	0.58	0.64	0.89	0.89	–	–	–	–
		0.52	0.59	0.84	0.84	–	–	–	–
		–	–	–	–	0.55	0.55	0.9	0.89
	Leakage current (max.) (Vin = 400 VAC, Pmax) (Vin = 480 VAC, Pmax) (Vin = 230 VAC, Pmax)	0.4 mA	0.9 mA	1.3 mA	0.7 mA	–	–	–	–
0.5 mA		1.1 mA	1.6 mA	0.9 mA	–	–	–	–	
–		–	–	–	0.3 mA	0.4 mA	0.7 mA	1.4 mA	
Inrush current (max.) (Pmax) (Note 1)	30 A	30 A	40 A	50 A	35 A	35 A	75 A	75 A	
Output	Voltage adjustment range	22.5...26.4 VDC min.							
	Tolerance adjustment accuracy	± 0.5%							
	Ripple & noise (Pmax.)	200 mV max.							
	Load variation influence	± 2% max.							
	Input variation influence	± 0.5% max.							
	Temperature variation influence	± 0.01%/°C							
	Startup time (max.)	1.7 s	1.5 s	1.0 s	0.1 s	0.9 s	1.0 s	1.3 s	0.1 s
	Hold time (min.) (Vin = 200 VAC, Pmax) (Vin = 400 VAC, Pmax) (Vin = 480 VAC, Pmax) (Vin = 230 VAC, Pmax)	–	–	–	–	10 ms	4 ms	4 ms	5 ms
		21 ms	17 ms	11 ms	14 ms	–	–	–	–
		25 ms	26 ms	24 ms	26 ms	–	–	–	–
		–	–	–	–	20 ms	10 ms	8 ms	13 ms
	Protection	- Short circuit protection with automatic reset - Over load protection - Over voltage protection (Note 4)							
	Parallel operation	Yes (for two units)							
Serial operation	Yes (for two units)								
Indicator	Yes (Green LED)								
Others	Heat radiation	Natural air cooling							
	Ambient temperature (Note 2)	-10...60 °C (de-rating: 2%/°C for 50...60 °C)							
	Storage temperature	-25...85 °C							
	Ambient humidity	25...85%							
	Dielectric strength	500 VAC 50/60 Hz (Output - P.E.) Comply to EN60950 F: 2.5 kVAC 50/60 Hz (Input - P.E.) J: 1.5 kVAC 50/60 Hz (Input - P.E.)							
	Insulation resistance	500 M Ω min. at 500 VDC: P.E. - Output							
	EMC	EN55022 class A, EN55011 class A, EN50081-2 EN61000-6-2, EN61000-3-2 class A							
	Approved standards	IEC60950, EN60950, UL60950, CSA22.2-60950 UL508 (Listing), CSA22.2-14, EN50178, EN60204-1							
	Life expectancy (Note 3)	10 years (typical)							
	Weight	750 g	1.0 kg	2.65 kg	4.75 kg	750 g	1.0 kg	2.65 kg	4.75 kg

Note 1. Measured at 25 °C, and cold start condition. (F: Vin = 480 VAC, J: Vin = 230 VAC, duration < 500 μs)

2. For UL and CSA, -105 to 50 °C (de-rating: 2%/°C for 40-50 °C only for 40 A model).
3. Under the ambient temperature of 40 °C, and a load rate of 50%.
4. Over voltage protection is provided for 5A, 10A and 20A models.

For 40A model, no overvoltage protection is provided.

Engineering Data

Definition of Inrush Current, Start up Time and Hold Time

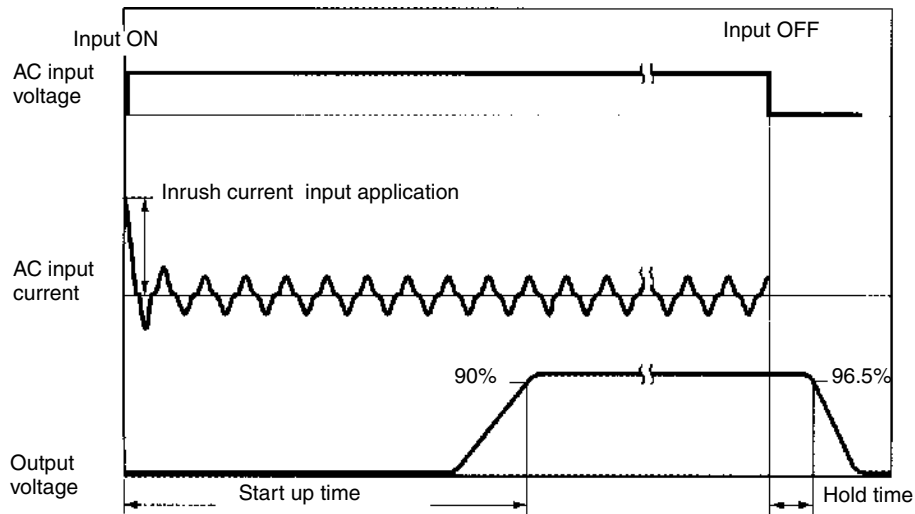

Overload Protection

The Power supply is provided with an overload protection function that protect the load and the power supply from possible damage by over current. When the output current rises above between 105 to 130% of the rated current, the protection function is triggered, decreasing the output voltage. When output current falls within the rated range, the overload protection function is automatically cleared.

Overvoltage Protection

(except for 40 A model)

If output voltage exceed the rated voltage more than 20% (50% at maximum) by some reason, then the output voltage will be turned OFF automatically for safety. To restart the S8PE, turn OFF the input voltage, wait for about one minute, then apply the input power again.

De-rating Curve

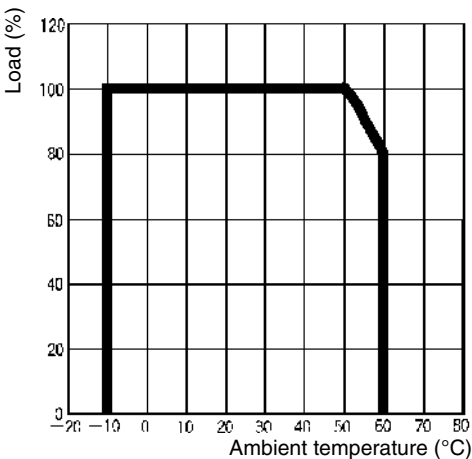

For UL and CSA the maximum temperature is 50°C (with derating of 2%/°C from 40 °C to 50 °C, only for 40 A model)

Operation

■ Block Diagram

S8PE-F12024CD/J12024CD (5 A)
 S8PE-F24024CD/J24024CD (10 A)

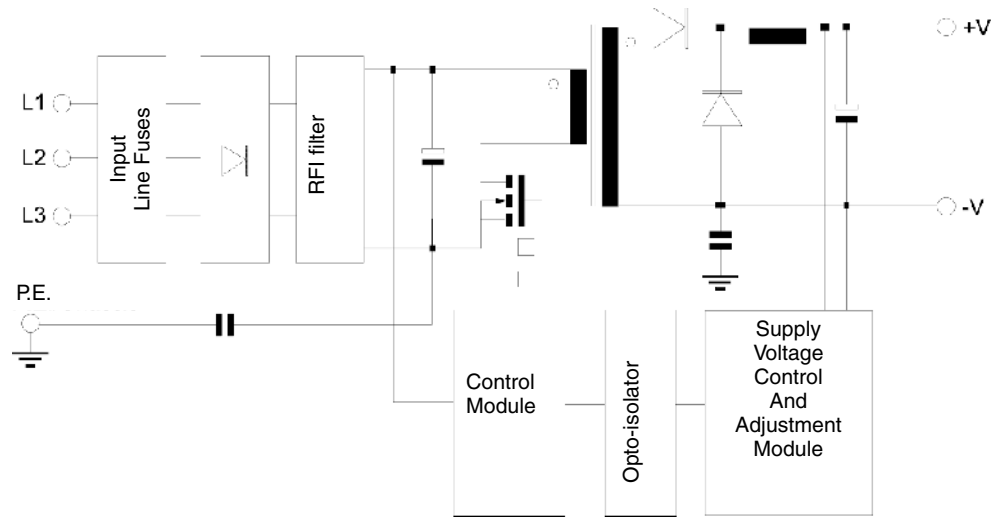

S8PE-F48024C (20 A)
 S8PE-F48024CD/J48024CD (20 A)

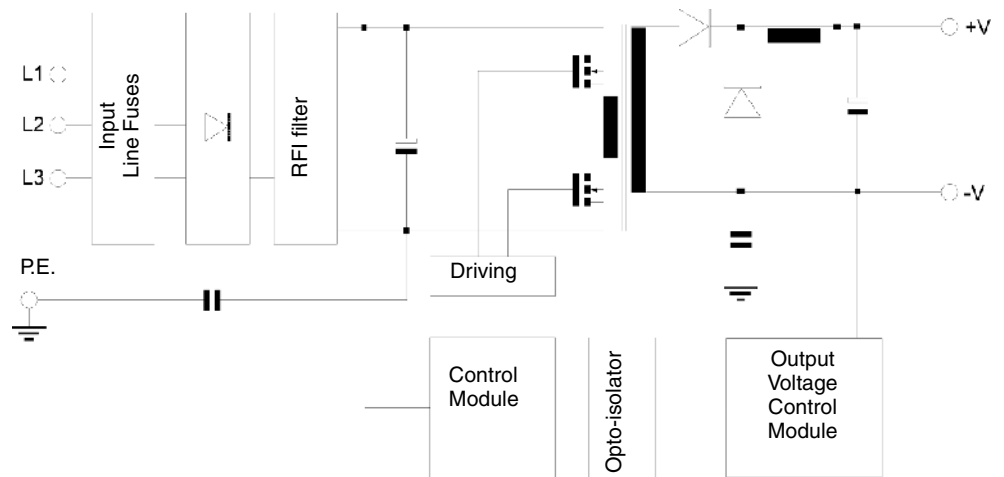

S8PE-F96024C/J96024C (40 A)

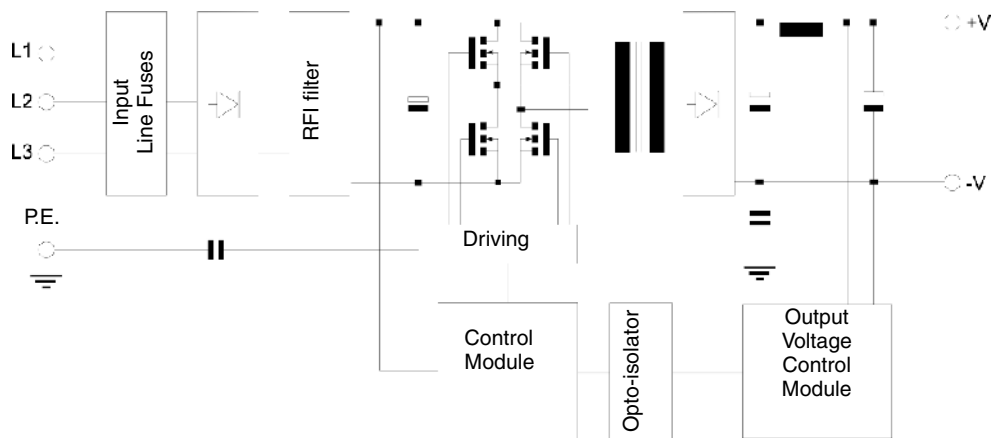

Dimensions and Installation

Note: All dimensions shown are in millimeters.

S8PE-F12024CD/J12024CD (5 A)

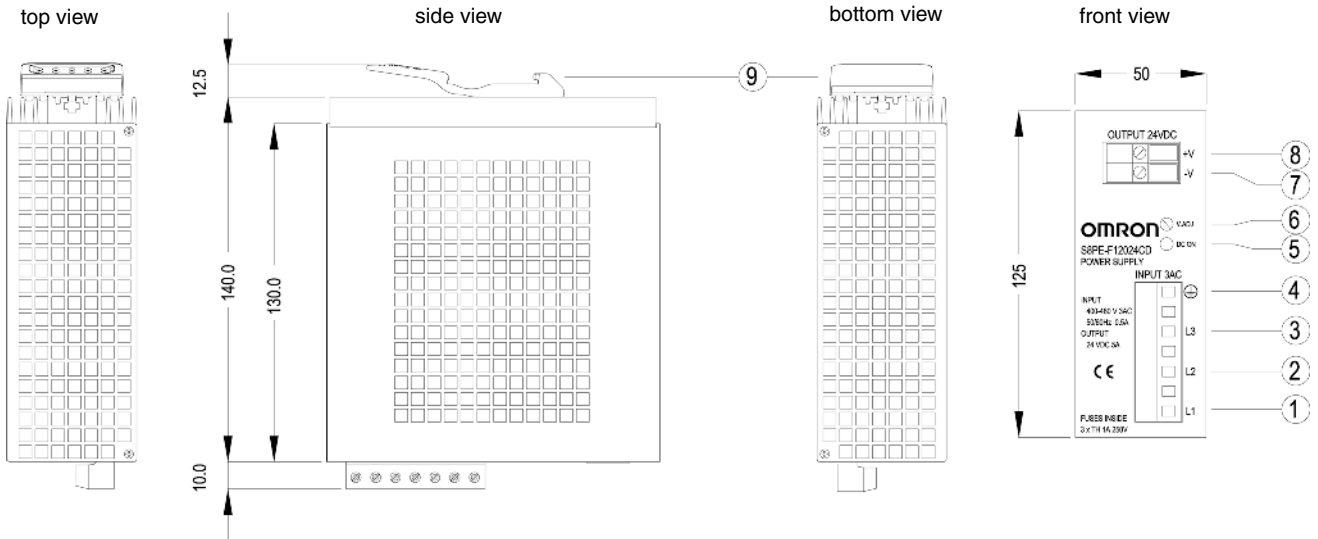

S8PE-F24024CD/J24024CD (10 A)

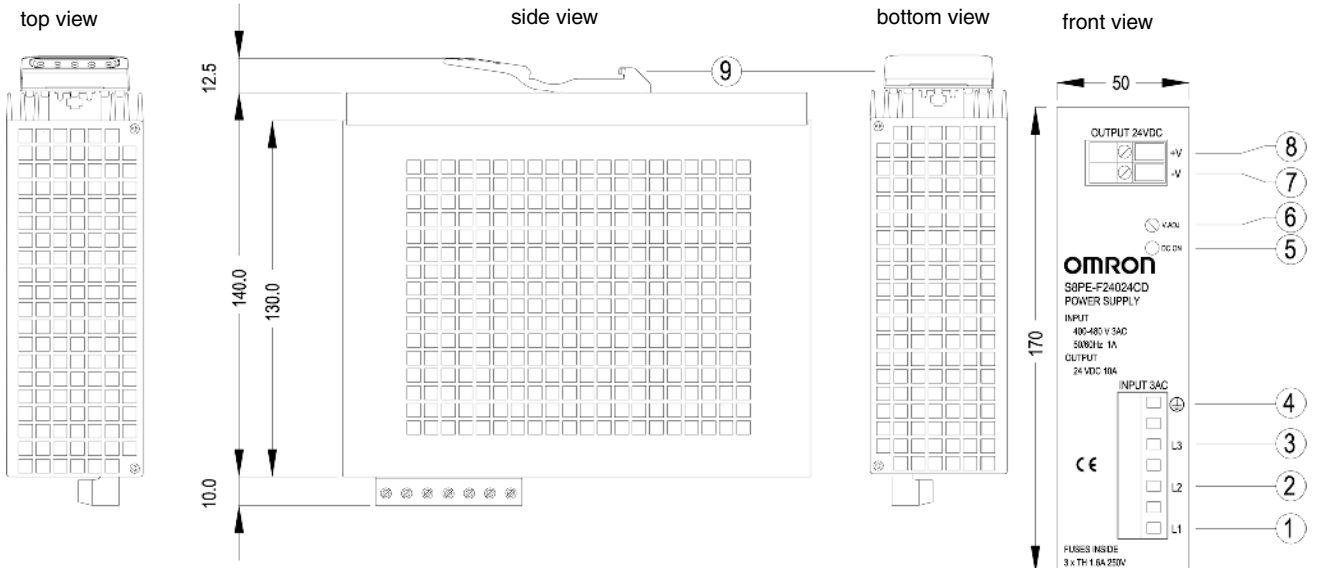

①	AC INPUT L1	⑥	Output Voltage adjustment trimmer V.ADJ
②	AC INPUT L2	⑦	DC OUTPUT -V
③	AC INPUT L3	⑧	DC OUTPUT +V
④	Protective Earth (P.E.)	⑨	35 mm DIN-rail attachment
⑤	DC OUTPUT indicator		

S8PE-F48024C (20 A)
S8PE-F48024CD/J48024CD (20 A)

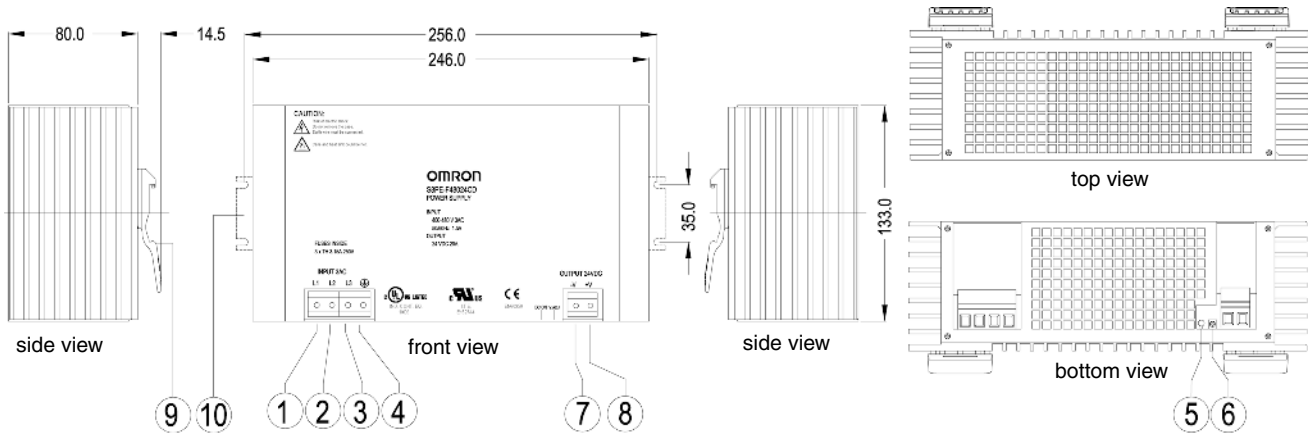

S8PE-F96024C/J96024C (40 A)

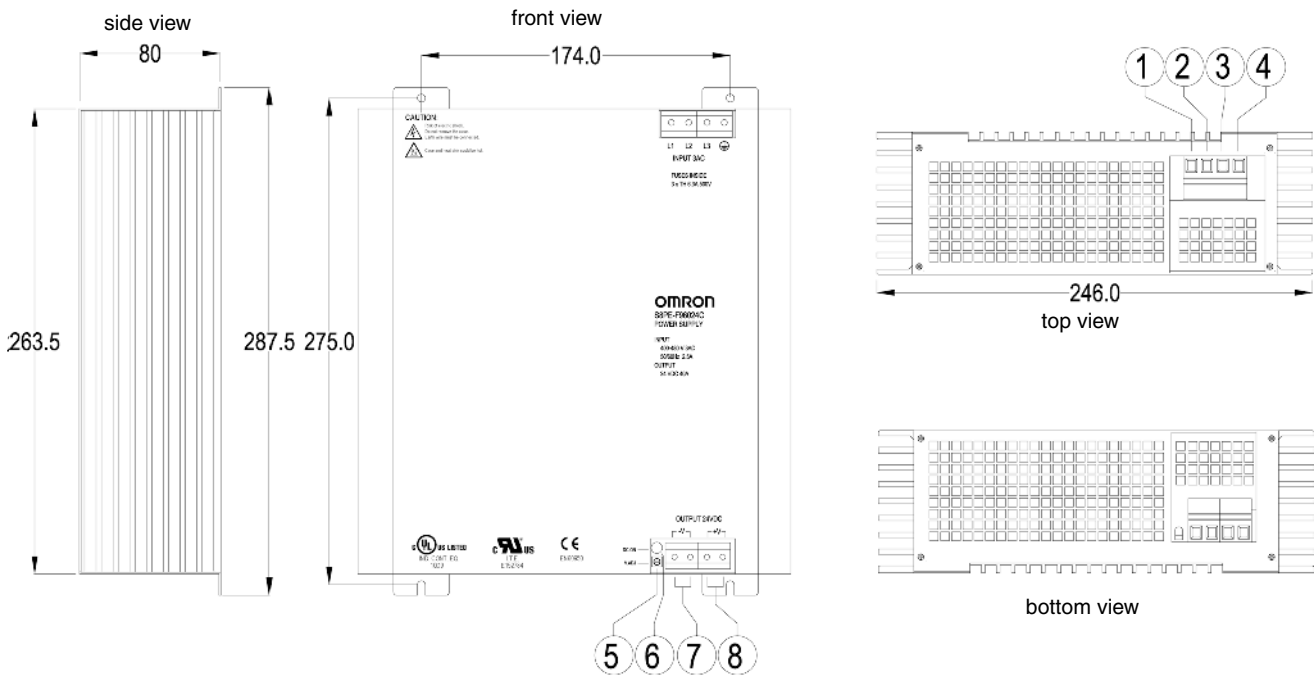

①	AC INPUT L1	⑥	Output Voltage adjustment trimmer V.ADJ
②	AC INPUT L2	⑦	DC OUTPUT -V
③	AC INPUT L3	⑧	DC OUTPUT +V
④	Protective Earth (P.E.)	⑨	35 mm DIN-rail attachment for S8PE-F48024CD/J48024CD type only
⑤	DC OUTPUT indicator	⑩	Fixing bracket for S8PE-F48024C type only

Notice

Three phase input operation when one phase is missing

The S8PE will in most cases continue to operate even after the loss of one phase of the supply. The performance specifications are of course not guaranteed under these conditions. As the loss of one phase puts additional stress on some components, the life span of the unit could be shortened. It is prudent therefore to regularly check for signs of the following possible conditions.

1. Input terminals wiring open/loose.
2. Incorrect / no voltage on one or more phases of the supply.
3. Abrupt or periodical loss of input voltage.

Three phase input switch off

In order to switch off the Power Supply completely: all 3 phases need to be switched off.

Mounting

To improve and maintain the reliability of the Power Supply over a long period, adequate consideration must be taken to heat radiation.

The S8PE is designed to radiate heat by natural air cooling, therefore, mount the S8PE so that enough air flow takes place around the power supply.

If installing S8PEs closely, keep the minimum distance of 10 cm at 50 °C ambient, 5 cm at 20 °C ambient.

Generating (±) Output Voltage

An output of ± can be generated as shown below, since the S8PE has a floating output.

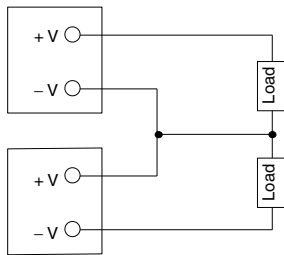

Serial Operation

As shown below, the output voltage from each S8PE can be added. Types must be the same.

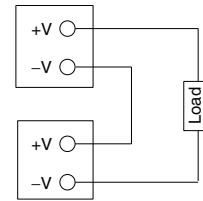

Parallel Operation

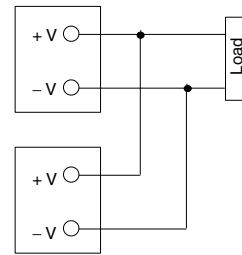

As shown below, The Power supply can use for parallel operation. All the output voltage of each S8PEs should be exactly the same. Also, make sure that the thickness and the length of all wires connected to the load are the same to ensure that the wires will have no voltage drop difference. Types must be the same.





Safety Precautions

■ Safety Signal words

This document uses the following signal words to mark safety precautions for the S8PE. These precautions provide important information for the safe application of the product. You must be sure to follow the instructions provided with safety signal words.

 WARNING	Indicates information that, if ignored, could possibly result in loss of life or seriously injury.
 Caution	Indicates information that, if ignored, could result in relatively serious or minor injury, damage to the product, or faulty operation.

 **WARNING**
 Be sure to connect the grounding line. Not doing so may result in electric shock.

 **Caution**
 Do not attempt to disassemble the Power Supply or touch its internal parts while power is being supplied. Doing so may result in electric shock.

 **Caution**
 Do not touch the S8PE while the power is being supplied or immediately after the power is turned OFF. Otherwise hot Switching Power Supply.

ALL DIMENSIONS SHOWN ARE IN MILLIMETERS.

To convert millimeters into inches, multiply by 0.03937. To convert grams into ounces, multiply by 0.03527.

Cat. No. M044-E1-04

In the interest of product improvement, specifications are subject to change without notice.